

**TB7100** base station  
**TB8100** base station

# TBA0M01 & TBA0M02 Tone Remote and Alarm Interface Installation and Operation Manual



MBA-00030-01  
Issue 1  
September 2006

## Contact Information

### Tait Radio Communications Corporate Head Office

Tait Electronics Limited  
P.O. Box 1645  
Christchurch  
New Zealand

For the address and telephone number of regional offices, refer to the TaitWorld website:

Website: <http://www.taitworld.com>

### Technical Support

For assistance with specific technical issues, contact Technical Support:

E-mail: [support@taitworld.com](mailto:support@taitworld.com)

Website: <http://support.taitworld.com>

## Copyright and Trademarks

All information contained in this manual is the property of Tait Electronics Limited. All rights reserved.

This manual may not, in whole or in part, be copied, photocopied, reproduced, translated, stored, or reduced to any electronic medium or machine-readable form, without prior written permission from Tait Electronics Limited.

The word TAIT and the TAIT logo are trademarks of Tait Electronics Limited.

All trade names referenced are the service mark, trademark or registered trademark of the respective manufacturers.

## Disclaimer

There are no warranties extended or granted by this manual. Tait Electronics Limited accepts no responsibility for damage arising from use of the information contained in the manual or of the equipment and software it describes. It is the responsibility of the user to ensure that use of such information, equipment and software complies with the laws, rules and regulations of the applicable jurisdictions.

## Enquiries and Comments

If you have any enquiries regarding this manual, or any comments, suggestions and notifications of errors, please contact Technical Support.

## Updates of Manual and Equipment

In the interests of improving the performance, reliability or servicing of the equipment, Tait Electronics Limited reserves the right to update the equipment or this manual or both without prior notice.

## Intellectual Property Rights

This product may be protected by one or more patents of Tait Electronics Limited together with their international equivalents, pending patent applications and registered trade marks: NZ 508054, NZ 508340, NZ 508806, NZ 508807, NZ 509242, NZ 509640, NZ 509959, NZ 510496, NZ 511155, NZ 511421, NZ 516280/519742, NZ 519118, NZ 519344, NZ 520650/537902, NZ 521450, NZ 524509, NZ 524537, NZ 524630, NZ 530819, NZ 534475, NZ 534692, NZ 535471, NZ 536945, NZ 537434, NZ 534369, NZ 522236, NZ 524378, AU 2003281447, AU 2002235062, AU 2004216984, CA 2439018, EU 03784706.8, EU 02701829.0, EU 04714053.8, GB 23865476, GB 2386010, GB 2413249, GB 0516092.4, US 60/613748, US 60/539617, US 10/520827, US 10/468740, US 5,745,840, US 10/520827.

## To Our European Customers



Tait Electronics Limited is an environmentally responsible company which supports waste minimization and material recovery. The European Union's Waste Electrical and Electronic Equipment

Directive requires that this product be disposed of separately from the general waste stream when its service life is over. Please be environmentally responsible and dispose through the original supplier, your local municipal waste "separate collection" service, or contact Tait Electronics Limited.

# Contents

---

|  |           |
|--|-----------|
| <b>Preface</b> .....                         | <b>7</b>  |
| Scope of Manual .....                        | 7         |
| Circuit Board Information .....              | 7         |
| Associated Documentation .....               | 7         |
| Document Conventions .....                   | 8         |
| Publication Record .....                     | 8         |
| <br>   |           |
| <b>1 Description</b> .....                   | <b>9</b>  |
| 1.1 Tone Remote .....                        | 9         |
| 1.2 Alarm Monitoring and Confirmations ..... | 10        |
| 1.3 Voting Tones .....                       | 10        |
| 1.4 Other Features .....                     | 11        |
| 1.5 Operating Controls .....                 | 12        |
| <br>   |           |
| <b>2 Specifications</b> .....                | <b>15</b> |
| <br>   |           |
| <b>3 Regulatory Information</b> .....        | <b>19</b> |
| 3.1 Canada .....                             | 19        |
| 3.2 United States Of America .....           | 19        |
| 3.3 Europe .....                             | 21        |
| 3.4 New Zealand .....                        | 21        |
| 3.5 Australia .....                          | 22        |
| 3.6 Hong Kong .....                          | 22        |
| 3.7 Singapore .....                          | 22        |
| <br>   |           |
| <b>4 Circuit Operation</b> .....             | <b>23</b> |
| 4.1 Circuit Overview .....                   | 23        |
| 4.2 Tone Detection .....                     | 24        |
| 4.3 Alarm Monitoring .....                   | 26        |
| 4.4 Confirmations .....                      | 27        |
| 4.5 Clearing Alarms and Confirmations .....  | 28        |
| 4.6 Voting Tone Operation .....              | 29        |
| 4.7 Use of Test Microphone .....             | 31        |
| 4.8 Test Modes .....                         | 31        |
| <br>   |           |
| <b>5 Before Installing</b> .....             | <b>35</b> |
| 5.1 ESD Precautions .....                    | 35        |

|          |  |           |
|----------|--|-----------|
| 5.2      | Installing the TBA0M0x . . . . .                         | 36        |
| 5.3      | Dispatch Consoles . . . . .                              | 36        |
| <b>6</b> | <b>Interfacing the TBA0M0x with the TB7100 . . . . .</b> | <b>37</b> |
| 6.1      | Cable connection between TBA0M0x and TB7100 . . . . .    | 37        |
| 6.2      | TB7100 system interface board links . . . . .            | 39        |
| 6.3      | TB7100 Programming . . . . .                             | 40        |
| 6.4      | TBA0M0x Programming . . . . .                            | 43        |
| 6.5      | The Aux Connector . . . . .                              | 44        |
| <b>7</b> | <b>Interfacing the TBA0M0x with the TB8100 . . . . .</b> | <b>49</b> |
| 7.1      | Connecting to a TB8100 Base Station . . . . .            | 49        |
| 7.2      | Power supply . . . . .                                   | 50        |
| 7.3      | TBA0M0x Input/Output Connections . . . . .               | 52        |
| 7.4      | The Base Station Interface Connector . . . . .           | 52        |
| 7.5      | TB8100 SIF Programming . . . . .                         | 53        |
| 7.6      | Alternative Pin Allocations . . . . .                    | 54        |
| 7.7      | TBA0M0x Programming . . . . .                            | 56        |
| 7.8      | The Aux Connector . . . . .                              | 58        |
| <b>8</b> | <b>Level Configuration . . . . .</b>                     | <b>67</b> |
| 8.1      | Line Interface . . . . .                                 | 68        |
| 8.2      | Equipment Setup for Level Configuration. . . . .         | 68        |
| 8.3      | Tx/Rx Level Configuration (TB7100) . . . . .             | 69        |
| 8.4      | Tx/Rx Level Configuration (TB8100) . . . . .             | 71        |
| 8.5      | Line-In Level . . . . .                                  | 75        |
| 8.6      | Line-Out Level . . . . .                                 | 76        |
| <b>9</b> | <b>Troubleshooting . . . . .</b>                         | <b>79</b> |
| 9.1      | Fault Finding . . . . .                                  | 79        |
| 9.2      | Troubleshooting Setup Problems. . . . .                  | 79        |

# List of Illustrations

---

|            |  |    |
|------------|--|----|
| Figure 4.1 | High Level Block Diagram . . . . .                                     | 24 |
| Figure 4.2 | Signal Flow . . . . .  | 30 |
| Figure 4.3 | Mode switching cycle . . . . .   | 32 |
| Figure 5.1 | Typical antistatic bench set-up . . . . .                              | 35 |
| Figure 6.1 | TBA0M0x to TB7100 Cable connection . . . . .                           | 37 |
| Figure 6.2 | Sample Channel Select Line programming . . . . .                       | 41 |
| Figure 6.3 | Programmable I/O BCD tab . . . . .                                     | 41 |
| Figure 6.4 | Sample configuration of Channel Selection . . . . .                    | 42 |
| Figure 6.5 | Programming RSSI Signal Strength . . . . .                             | 43 |
| Figure 6.6 | TBA0M0x Aux connector . . . . .  | 44 |
| Figure 7.1 | TBA0M0x to TB8100 cable connection . . . . .                           | 50 |
| Figure 7.2 | PMU auxiliary DC output pin allocations . . . . .                      | 51 |
| Figure 7.3 | Reciter system interface board pin allocations . . . . .               | 51 |
| Figure 7.4 | TBA0M0x rear panel . . . . .   | 52 |
| Figure 7.5 | Base station interface connector . . . . .                             | 52 |
| Figure 7.6 | TB8100 SIF Pin Allocations . . . . .                                   | 54 |
| Figure 7.7 | Programming RSSI Signal Strength . . . . .                             | 57 |
| Figure 7.8 | TBA0M0x Aux connector . . . . .  | 58 |
| Figure 8.1 | TBA0M0x setup . . . . .  | 67 |
| Figure 8.2 | Line Interface pin allocations . . . . .                               | 68 |
| Figure 8.3 | Rack and test equipment setup . . . . .                                | 69 |
| Figure 8.4 | Location of level adjustment pots on TB7100 rear panel . . . . .       | 70 |
| Figure 8.5 | TB8100 Service Kit – Signal Path tab for the default channel . . . . . | 72 |



# Preface

---

## Scope of Manual

This manual contains information on installing and configuring the TBA0M01 or TBA0M02 tone remote. It also provides circuit descriptions for the module.

## Circuit Board Information

Circuit board information is provided in the separate TBA0M01/2 Tone Remote and Alarm Interface PCB Information Package. Included in the package is a parts list, grid references, PCB layouts and circuit diagrams.

Circuit boards may change without notice. The latest parts lists are available from your nearest Customer Service Organisation.

## Associated Documentation

TB7100 Installation and Operation Manual.

TB7100 Programming Application Online Help.

TB7100 Calibration Application Online Help.

TB8100 Installation and Operation Manual.

TB8100 Service Kit and Alarm Center User's Manuals and online Help.

TB8100 Calibration Kit User's Manual and Online Help.

Technical notes are published from time to time to describe applications for Tait products, to provide technical details not included in manuals, and to offer solutions for any problems that arise.

# Document Conventions

Within this manual, four types of alerts are given to the reader: Warning, Caution, Important and Note. The following paragraphs illustrate each type of alert and its associated symbol.



**Warning!!** This alert is used when there is a potential risk of death or serious injury.



**Caution** This alert is used when there is a risk of minor or moderate injury to people.



**Important** This alert is used to warn about the risk of equipment damage or malfunction.



**Note** This alert is used to highlight information that is required to ensure procedures are performed correctly.

# Publication Record

| Issue | Publication Date | Description             |
|-------|------------------|-------------------------|
| 1     | September 2006   | Replaces MBA0M01-00-812 |



# 1 Description

---

The TBA0M01 and TBA0M02 are tone-operated remote controller products otherwise known as tone remotes. The TBA0M01 has a single tone remote module while the TBA0M02 has two modules. The TBA0M02 is used for two channel subrack systems with each tone remote module dedicated to a channel. The two modules of the TBA0M02 are completely independent. The TBA0M01 and TBA0M02 are collectively referred to as the TBA0M0x tone remote product.

Features include alarm monitoring, voting tone generation and simple high-site control. The TBA0M0x interfaces either a two or four-wire leased circuit to TB8000 and TB7000 series base station products and so enables a dispatch console (or desktop controller) to control and monitor a remote base station. The TBA0M01 and the TBA0M02 are both 2U subracks designed to fit into a standard 19 inch rack or cabinet, just above or below the base station. A 25-way cable provides all the connections, including DC power from each TB8000 reciter or TB7100 base station to each TBA0M0x module. The TBA0M0x is configured using the Tone Remote Programming Application (TRPA) version 1.08 or later on a PC.

## 1.1 Tone Remote

The TBA0M0x tone remote enables a remotely located user to:

- key a transmitter
- defeat a receiver's CTCSS mute (to monitor a channel)
- change the set channel (up to 128 channels)
- change between base station and repeater modes (repeater knockdown)
- monitor and cancel alarms
- turn repeater site equipment on or off (highsite Control)
- loop back line audio (4 wire line interface only)

This is achieved using three standard tone signalling schemes for ease of integration into existing control systems and choice of vendor for office/control room equipment. These schemes are:

### ■ EIA tone remote using a single function tone.

In this system when the control room user presses the transmit key, the line control equipment sends a 120 ms long burst of high level guard tone (HLGT – usually 2175 Hz at +10 dBm to line). This is followed by a single 40 ms function tone at 0 dBm to line. The available tone set is 650 Hz to 2050 Hz in 100 Hz steps. This function tone can instruct the tone remote to change channel, monitor the radio channel (defeat receiver CTCSS) or a variety of other functions. Following these initial

tone bursts a low level guard tone (LLGT – usually 2175 Hz at –20 dBm) is sent to line and speech is gated onto line (at approximately 0 dBm peak level). This continues until the user releases the transmit key. This removes speech from the line and the low level guard tone ceases.

- **EIA enhanced tone remote using two function tones.**

This is a variant of the above system where two function tones are sent one after the other in the period between the high level guard tone and the low level guard tone. The tone set is also expanded (650 Hz to 2050 Hz in 100 Hz steps) to give 225 possible combinations which can be allocated to various actions. The duration of both high level guard tone and function tones can be varied.

- **Simple Transmitter keying using low level guard tone only.**

This is used where complex functionality is not required.

## 1.2 Alarm Monitoring and Confirmations

The TBA0M0x can monitor a total of eight alarms, six external closure alarms, a low voltage (power supply) alarm and a line alarm (line fail indication). Two of the external closure alarms can be triggered by base station digital outputs while the other four can be triggered by inputs on the TBA0M0x auxiliary connector. If alarms are triggered the TBA0M0x can be programmed to generate tone sequences (DTMF, Selcall or function tones) and/or enable auxiliary outputs, to alert system users of a problem. The tone sequences can be sent to line and/or radio. The auxiliary outputs can be directed to the TBA0M0x auxiliary connector or to the base station's digital inputs where they can be used to initiate actions based on user programmable tasks (using the Task Manager in the TB8100 Service Kit or by using the TB7100 Programming Application).

Additionally the TBA0M0x can be programmed to respond to as many as eight different non-alarm triggers. These can be used as confirmation that an event has occurred. Confirmations can be programmed to occur in the event of power-up, channel change and/or the detection of up to six user defined function tones. In the same way as for alarms, the TBA0M0x can generate tone sequences and/or enable auxiliary outputs in response to a confirmation.

## 1.3 Voting Tones

The TBA0M0x can also generate voting tones where a four-wire line interface is used. Voting systems are used where several base station receivers are tuned to the same radio channel and located at different sites, sending audio back to a central control where the best quality audio must be selected or “voted upon”. Tone on Idle or Sliding Voting Tones can be generated to interface the base station to a wide variety of industry standard Radio Voting systems.

In Tone on Idle applications, a tone (normally the same frequency as LLGT) is transmitted to line when the base station's receiver is muted. When the tone disappears, control room equipment can perform signal to noise measurements on incoming audio lines and select the best for feeding to the control room user.

In Sliding Voting Tone systems, a tone is transmitted to line whose frequency is proportional to the base station receiver's RSSI. Control room equipment determines which receiver has the highest RSSI and thus selects which line carries the highest quality incoming audio.

## 1.4 Other Features

- Programmable Morse Code Encoder for automatic station identification (CWID)
- User programmable Line levels
- Programmable Transmit and Receive audio path delays
- Programmable (on/off) notch filtering.

# 1.5 Operating Controls

## 1.5.1 Layout and Controls

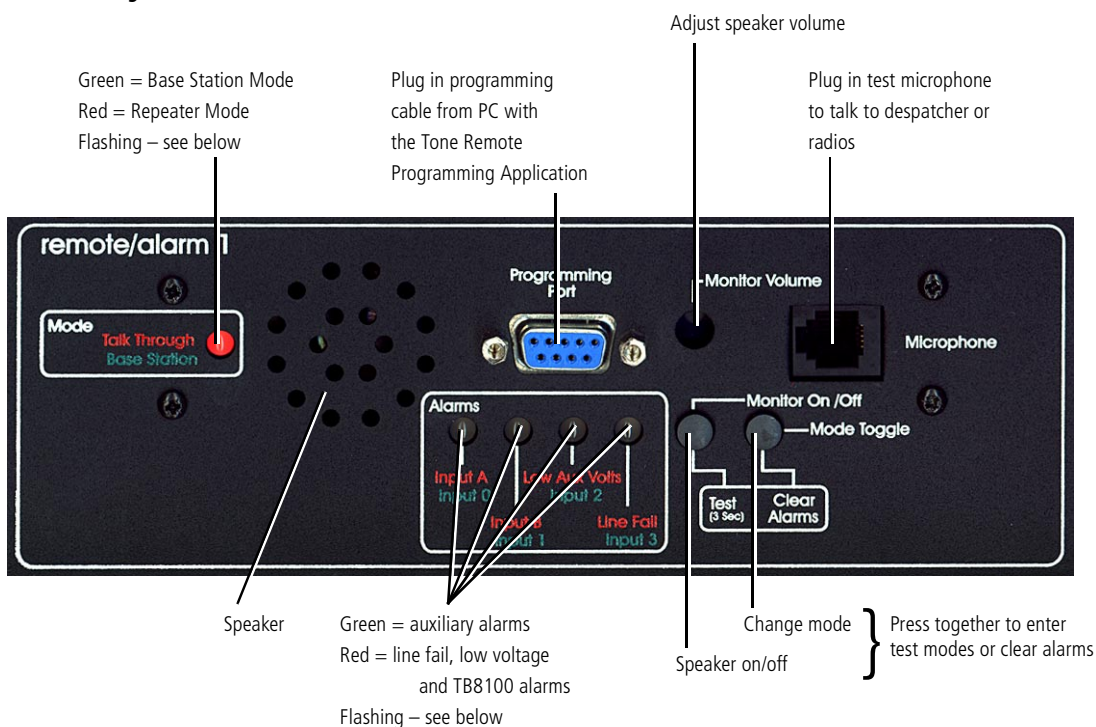

## 1.5.2 Mode LED

The colour of the Mode LED on the front panel indicates the TBA0M0x mode of operation:

- Green = Base Station Mode
- Red = Repeater (talk-through) Mode

The LED flashes in different ways when particular conditions occur.

| Flash Rate                         | Condition  |
|------------------------------------|--|
| <br>equal<br>0.3s on/0.3s off      | Module is linked with TBA0M0x Programming Application        |
| <br>long flash<br>1s on/0.3s off   | Microprocessor has detected an internal communications error |
| <br>short off<br>0.3s on/0.08s off | Speaker is on.   |



Where two or more conditions occur at the same time, the precedence is in the order shown above (i.e. module linked has the highest priority, followed by microprocessor error, then speaker on).

### 1.5.3 Alarm LEDs

The alarm LED turns on only when its alarm condition has been latched. The colour of the LED indicates the source of the alarm trigger:

- Green – Assigned to the four external closure alarm triggers, Alarm Input0 to Input3.
- Red – Assigned to line fail, low voltage and the two external closure alarm triggers, Alarm InputA and InputB.

The LED flashes in different ways as indicated below.

| Flash Rate and Colour   | Alarm   |
|---|---|
| <br>green very short off<br>0.32s on/0.01s off                       | External closure alarm Input0 to Input3.                          |
| <br>red short off<br>0.32s on/0.1s off                               | Line fail, low voltage or external closure alarm InputA or InputB |
| <br>alternating red and green<br>0.32s on/0.1s off/0.32s on/0.1s off | Combination of above alarm sources.                               |

The factory configuration of the I/O resistor links (see [Section 7.3](#)) means that by default the green LEDs associated with external closure alarms are triggered by inputs on the TBA0M0x Auxiliary connector while the two (external closure) red LEDs are associated with alarms triggered by the TB8100 digital outputs. These associations may change if the I/O configuration is changed.



**Note** Press the Monitor and Mode Toggle buttons together to reset all alarms.



## 2 Specifications

---

The performance figures given are minimum figures, unless otherwise indicated, for equipment operating at standard room temperature (+22°C to +28°C) and standard test voltage (13.8V<sub>DC</sub>).

Details of test methods and the conditions which apply for Type Approval testing in all countries can be obtained from Tait Electronics Ltd.

### General

---

#### Supply Voltage

|                       |                           |
|-----------------------|---------------------------|
| Operating Voltage     | 10.8 to 16V <sub>DC</sub> |
| Standard Test Voltage | 13.8V <sub>DC</sub>       |
| Polarity              | negative earth only       |

---

|                |           |
|----------------|-----------|
| Supply Current | 250mA max |
|----------------|-----------|

---

|                             |              |
|-----------------------------|--------------|
| Operating Temperature Range | -30 to +60°C |
|-----------------------------|--------------|

---

#### Dimensions – module only

|        |       |
|--------|-------|
| Height | 56mm  |
| Width  | 160mm |
| Length | 280mm |

---

#### Dimensions – with front panel

|         |                  |
|---------|------------------|
| Height  | 2U               |
| Width   | Standard 19 inch |
| Depth   | 288mm            |
| Weight  |                  |
| TBA0M01 | 2.4kg            |
| TBA0M02 | 3.9kg            |

---

### Input Line Levels

---

Line-In (Level required to produce a transmitter output at 60% full system deviation)

|                    |                                   |
|--------------------|-----------------------------------|
| Programmable       | -27dBm to +3dBm                   |
| Maximum input peak | +7dB relative to programmed level |

---

## Output Line Levels

---

Line-Out (Radio receiver level to TBA0M0x must be  $230\text{mV}_{\text{rms}}$ )

|                     |                                    |
|---------------------|------------------------------------|
| Programmable        | -27 dBm to -1 dBm                  |
| Dynamic range       | +7 dB relative to programmed level |
| Maximum output peak | +5.5 dBm                           |

---

For compliance with TIA/EIA-IS-968, CS-03 (Canada), PTC200 (New Zealand) and HKTA 2023 (Hong Kong)

|                                   |                       |
|-----------------------------------|-----------------------|
| Programmable level must be set to | $\leq -10\text{ dBm}$ |
|-----------------------------------|-----------------------|

---

For compliance with ACA TS002 (Australia)

|                                   |                       |
|-----------------------------------|-----------------------|
| Programmable level must be set to | $\leq -11\text{ dBm}$ |
|-----------------------------------|-----------------------|

---

For compliance with TS PSTN1 (Singapore)

|                                   |                      |
|-----------------------------------|----------------------|
| Programmable level must be set to | $\leq -7\text{ dBm}$ |
|-----------------------------------|----------------------|

---

## Radio Levels

---

From Radio Receiver  $230\text{mV}_{\text{rms}}$  at input of TBA0M0x  
(for 1 kHz tone at 60% full system deviation)  
(Note: This input of the TBA0M0x is high impedance)

---

To Radio Transmitter

|                     |  |
|---------------------|--|
| From Line-In        | -4.4 dBm   |
| From Radio Receiver | -4.4 dBm   |
|                     | (With receiver level to TBA0M0x set to $230\text{mV}_{\text{rms}}$ ) |

---

## Tone Remote

---

Keytone Sensitivity  $29\text{ dB}$  less than programmed Line-In level

---

Keytone Accept Bandwidth  $\pm 0.75\%$  typical ( $\pm 16\text{ Hz}$  at  $2175\text{ Hz}$ )  
(Speech at  $-10\text{ dBm}$ , keytone at  $-30\text{ dBm}$ )

---

Talkoff  
(Max. difference between speech and keytone)

|                |                        |
|----------------|------------------------|
| Two-wire mode  | $32\text{ dB}$ typical |
| Four-wire mode | $35\text{ dB}$ typical |

---



## Tone Remote (Continued)

|   |   |
|---|---|
| Programmable Guardtone Frequencies          | 1950, 2100, 2175, 2325, 2500, 2600, 2800, 2900, 2970, 3000 and 3100Hz |
| Programmable High Level Guard Tone Duration | 60 to 200ms   |
| Function Tone Frequencies                   | 650 to 2050Hz in 100Hz steps  |
| Function Tone Accept Bandwidth              | ±24Hz typical   |
| Maximum Number of Function Tones            | 2   |
| Programmable Function Tone Duration         | 20 to 100ms   |

## Audio Response

|                                 |   |
|---------------------------------|---|
| Frequency Response              | ±1 dB 300Hz to 3kHz except at notch frequency |
| Notch Filter Bandwidth at -38dB | ±0.6% typical (±13Hz at 2175Hz)               |
| Notch Filter Bandwidth at -3 dB | ±1.28% typical (±28Hz at 2175Hz)              |
| Notch Filter Attenuation        | 38dB  |
| Audio Distortion                |   |
| From Line                       | <2.5%   |
| From Receiver                   | <2%   |
| Programmable Audio Delay        |   |
| Minimum                         | 0ms   |
| Maximum                         | 500ms   |
| Step                            | 1 ms  |

## Alarms

|                             |   |
|-----------------------------|---|
| Low Voltage Alarm Threshold | 10.7V to 14.1V (±0.05V)<br>programmable in 0.2V steps |
| Line Fail Alarm Timer       | off or 1 minute to 4 hours                            |
| External Closure Alarms     |   |
| Input Trigger               | First and subsequent falling edges                    |
| Input Threshold             | 1.5V (or to 0V via 3.3kΩ resistor)                    |
| Maximum Input Voltage       | 5V  |

## Alarms (Continued)

---

|                                   |   |
|-----------------------------------|---|
| Alarm/Confirmation Sequence       | 0 to 14 tones to radio and/or line<br>(and/or Aux output when enabled)                    |
| Programmable Signalling Standards | Selcall (CCIR, EIA, EEA, ZVEI, & DZVEI), DTMF and EIA<br>Tone Remote function tone format |
| Tone Carrier Deviation            | 70% nominal system deviation at 1 kHz (for test tone<br>set at 60%)                       |
| Alarm Pip Tone Frequency/Duration | 600 Hz/200 ms on tail of audio  |

---

## Morse Code

---

|  |                              |
|--|------------------------------|
| Sending Speed                                | 20 words per minute (PARIS)  |
| Maximum Code Length                          | 15.36 seconds                |
| Tone Frequency                               | 1200 Hz                      |
| Valid Station ID                             | alphanumeric only            |
| Repetition Rate                              | off or 1 to 60 minutes       |
| Carrier Deviation (for test tone set at 60%) | 20% nominal system deviation |

---

## Voting

---

|  |  |
|--|--|
| Programmable Tone-On-Idle Frequencies        | 1950, 2100, 2175, 2325, 2500, 2600, 2800, 2900,<br>2970, 3000 and 3100Hz |
| Programmable Sliding Voting Tone Frequencies | 2700 to 3500Hz   |
| Voting Tone Level To Line                    | -40dBr to -1 dBr<br>(Adjustable relative to Line-Out setting)            |

---

## Miscellaneous

---

|                                       |                                      |
|---------------------------------------|--------------------------------------|
| Auxiliary Output Rating               | open collector, 50V, 100mA (at 25°C) |
| Momentary Monitor (CTCSS Defeat) Time | off or 1 to 20 seconds               |

---

## 3 Regulatory Information

---

### 3.1 Canada

This product meets:

- Industry Canada Telecommunications Apparatus Compliance Specification CS-03. Registration No. 737A-10118A.
- Canadian ICES-003 (Radiated and conducted emissions, and electromagnetic susceptibility specifications) for Class B digital apparatus.

### 3.2 United States Of America

A copy of the Declaration of Conformity is available at [www.taitworld.com](http://www.taitworld.com)

This equipment complies with TIA/EIA/IS-968, Part 15 Class B of 47CFR and Part 68 of 47CFR as detailed below.

- **TIA/EIA/IS-968** (Telecommunications – Telephone Terminal Equipment – Technical Requirements). Adopted criteria of the Administrative Council on Terminal Attachments (ACTA).
- **Part 15 Class B of 47CFR** (Radiated and conducted emissions, and electromagnetic susceptibility specifications) of the FCC rules for the United States. Operation is subject to the following conditions:
  - a. This device may not cause harmful interference, and
  - b. This device must not accept any interference received, including interference that may cause undesired operation.

**Warning:**

This equipment has been tested and found to comply with the limits for a Class B digital device, pursuant to Part 15 of the FCC Rules. These limits are designed to provide reasonable protection against harmful interference in a residential installation. This equipment generates, uses, and can radiate radio frequency energy and, if not installed and used in accordance with the instructions, may cause harmful interference to radio communications. However, there is no guarantee that interference will not occur in a particular installation. If this equipment does cause harmful interference to radio or television reception, which can be determined by turning the equipment off and on, the user is encouraged to try to correct the interference in one or more of the following measures:

- Reorient or relocate the receiving antenna
- Increase the separation between the equipment and receiver
- Connect the equipment into an outlet on a circuit different from that to which the receiver is connected

- Consult the dealer or an experience radio/TV technician for help. Modifications not expressly approved by the manufacturer could void the the user's authority to operate the equipment under FCC rules.
- **Part 68 of 47CFR** (Connection of terminal equipment to the telephone network) of the Federal Communications Commission (FCC) rules and the requirements adopted by ACTA. On the rear face of this equipment is a label that contains, among other information, the product identifier i.e. US: 6FPNZL-34203-OT-N. If requested this number must be provided to the telephone company.

**Warnings:**

If this equipment, *TBA0M01 or TBA0M02 Tone remote and Alarm Interface*, causes harm to the telephone network, the telephone company will notify you in advance that temporary discontinuance of service may be required. But if advance notice isn't practical, the telephone company will notify the customer as soon as possible. Also, you will be advised of your right to file a complaint with the FCC if you believe it is necessary. The telephone company may make changes in its facilities, equipment, operations or procedures that could effect the operation of the equipment. If this happens the telephone company will provide advance notice in order for you to make necessary modifications to maintain uninterrupted service.

Connection to party line service is subject to state tariffs. Contact the state public utility commission, public service commission or corporation commission for information

If trouble is experienced with this equipment, *TBA0M01 or TBA0M02 Tone remote and Alarm Interface*, for repair or warranty information, please contact:

Tait North America Inc  
Building 1, Suite 450  
15740 Park Row  
Houston, Texas, 77084, USA  
Phone: 0800 320 4037  
Fax: 281 829-3320  
Mobile: 713-703-4991

Only approved Tait Dealer or Customer Service Organisations equipped with the necessary facilities should perform any servicing. Repairs attempted with incorrect equipment or untrained personnel may result in permanent damage. If the equipment, *TBA0M01 or TBA0M02 Tone Remote and Alarm Interface*, is causing harm to the telephone network, the telephone company may request that you disconnect the equipment until the problem is resolved.

### 3.2.1 Facility Interface and Service Order Codes

| Unit Configuration           | Function              | USOC Jack type | REN <sup>a</sup> | FIC <sup>b</sup> | SOC <sup>c</sup> |
|------------------------------|-----------------------|----------------|------------------|------------------|------------------|
| TBA0M01 or TBA0M02 two-wire  | two-wire leased line  | RJ-11C         | —                | Metallic         | 7.0Y             |
| TBA0M01 or TBA0M02 four-wire | four-wire leased line | RJ61X          | —                | Metallic         | 7.0Y             |

- a. Ringer Equivalence Number
- b. Facility Interface Code
- c. Service Order Code

## 3.3 Europe

For Declaration of Conformity refer to [eudocs.taitworld.com](http://eudocs.taitworld.com)

According to the requirements of the EC Council Directive: 1999/5/EC Radio Equipment and Telecommunications Terminal Equipment Directive,

The TBA0M01 or TBA0M02 Tone Remote and Alarm Interface complies with;

- EN 301 489-5 Radiated and conducted emissions, and electromagnetic susceptibility specifications.
- EN60950 : 2000 Electrical safety

## 3.4 New Zealand

This product complies with the following standards:

- PTC200 Requirements for analogue telecommunications equipment.
- AS/NZS 3548 Class B Radiated and conducted emissions specifications

### Warning:

TBA0M01 or TBA0M02 for use in New Zealand

“The grant of a Telepermit for any item of terminal equipment indicates only that Telecom New Zealand has accepted that the item complies with minimum conditions for connection to its network. It indicates no endorsement of the product by Telecom New Zealand, nor does it provide any sort of warranty. Above all, it provides no assurance that any item will work correctly in all respects with another item of Telepermitted equipment of a different make or model, nor does it imply that any product is compatible with all Telecom New Zealand’s Network services.”

“This equipment does not fully meet Telecom New Zealand’s impedance requirements. Performance limitations may occur when used in conjunction

with some parts of the network. Telecom New Zealand will accept no responsibility should difficulties arise in such circumstances.”

### **3.5 Australia**

This product complies with the following standards:

- AS/ACIF S006 – 2001 Telecommunications technical standard
- AS/ NZS 3260 Electrical safety
- AS/NZS 3548 Class B Radiated and conducted emissions specifications

### **3.6 Hong Kong**

This product complies with the Network Connection specification HKTA 2023

### **3.7 Singapore**

This product complies with the Type Approval specification IDA TS PSTN1

# 4 Circuit Operation

---

This section provides a description of the circuit and operation of the TBA0M0x tone remote.



**Note** Unless otherwise specified, the term “Tone Remote Programming Application” used in this and following sections refers to version 1.08 or later.

Refer to the TBA0M01/2 Tone Remote and Alarm Interface PCB Information Package for detailed information on identifying and locating components and test points on the main circuit board.

## 4.1 Circuit Overview

The TBA0M0x is connected to a leased line from control room equipment by means of an RJ45 connector. 600R transformers are used to couple the audio into and out of the TBA0M0x. On the secondary of these line matching transformers are analogue transmission switches which configure the line interface as either two or four-wire compatible. Audio from line is passed through a programmable electronic potentiometer (e-pot) level control circuit before entering a CODEC where it is digitised. Audio to line is output from the same line CODEC via a second programmable e-pot level control circuit.

The line CODEC is connected to a digital signal processor (DSP) which is also connected to a similar radio CODEC (the CTCSS CODEC is not used in this application). The radio CODEC receives audio from the receiver and sends audio to the transmitter via a 25-way cable connecting the TBA0M0x to the TB8000 series base station. Receiver audio is low frequency filtered to extend the radio CODEC's effective frequency range.

The DSP processes the digitised audio streams from the CODECs in accord with instructions sent to it by the TBA0M0x's microprocessor. The DSP can:

- detect high level guard tone, low level guard tone and function tones coming from line, notch filter line in and receiver audio (used to eliminate low level guard tone from Line-Out and transmitter audio);
- generate Selcall DTMF/function tone alarms and pip tones to Line-Out and transmitter audio;
- generate voting tones to Line-Out;
- generate morse code to transmitter audio;
- cross connect line and radio audio paths;
- adjusts the Line-In and Line-Out levels;

- mute audio from Line-In and receiver;
- delay the audio.

The microprocessor boot loads the DSP, interfaces with the user via the front panel switches and LEDs, interfaces with the Tone Remote Programming Application and runs the TBA0M0x state machines (alarm monitoring, alarm tone generation, high level guard tone/function tone/low level guard tone timing, RSSI/voting tone conversion etc.).

**Figure 4.1 High Level Block Diagram**

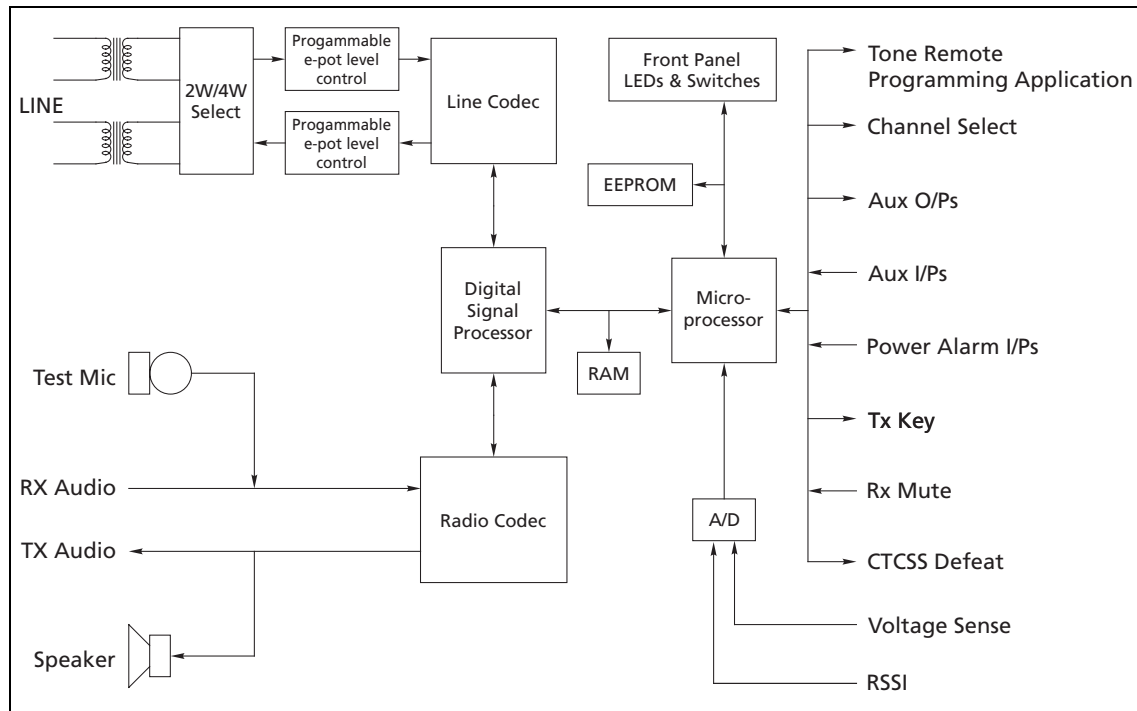

## 4.2 Tone Detection

In the quiescent state, audio on the Line-In pair is passed through the DSP (IC300) unfiltered to the TBA0M0x loudspeaker (which is connected to Tx audio – TP203). The audio is bandpass filtered to detect guard tone. In normal operation (keytone and function tone operation) the tone detector threshold is set for high level guard tone (HLGT).

If HLGT is detected, the DSP signals this detection to the microprocessor using the TONE\_DETECT line (TP300 is pulled low). The microprocessor instructs the DSP, using the asynchronous serial communications connection (TP306) between them, to switch on the in line guard tone notch filter, lower the threshold of the guard tone detector (so that it can detect low level guard tone – LLGT) and turn on the function tone detectors.



Where the TBA0M0x is operating in two-wire mode and receiver audio (RX audio) is being gated to line, the microprocessor will soft mute the RX audio first). The microprocessor then starts an internal timer, the duration of which is set by the HLG T and function tone times programmed by the Tone Remote Programming Application.

If a function tone is detected, the DSP signals the microprocessor using the CALL\_UP line (TP301 pulled low). The microprocessor then interrogates the DSP via the serial communications connection to find out what frequency was detected.

If no tones are detected and the timer expires, the microprocessor resets the DSP to its quiescent state. If two different frequencies are detected or if only one function tone frequency is decoded and the timer expires, the microprocessor decodes them/it into an action by reading data programmed into the EEPROM (IC312) by the Tone Remote Programming Application. The microprocessor then keys on the transmitter (PTT line) and instructs the DSP to turn off the function tone detectors and the talk-through gate (if it was on). If the function tone sequence decodes into a channel number that is different from the currently set channel, the microprocessor will output the channel number on lines CH0 to CH7. These lines may then be sent to the base station and/or the Aux connector depending on the configuration of I/O link resistors.



**Note** If channel selection is required for the base station, the appropriate Digital Inputs on the base station system interface will need to be configured as such.

As long as the DSP is detecting LLGT (indicated by a low level on TP300) the microprocessor will keep the transmitter keyed on. When the DSP fails to detect LLGT the microprocessor turns off the transmitter key and returns the DSP to the quiescent state.

When the TBA0M0x is programmed for keytone-only operation, the microprocessor keying of the transmitter follows the state of the TONE\_DETECT line from the DSP.

In the quiescent state when the receiver mute line (RX\_MUTE) goes low, the microprocessor instructs the DSP to gate audio from the receiver to Line-Out. If the line interface is two-wire, Line-In and Line-Out are joined and the RX audio will pass through the line internally to the loudspeaker. It will therefore also reach the guard tone detector. RX audio is therefore notch filtered at the guard tone frequency to prevent false guard tone detection. If the line interface is four-wire this filtering is unnecessary but the talk-through gate must be turned on to send RX audio to the loudspeaker. If the TBA0M0x is in Repeater Mode the transmitter is keyed and will remain so until the RX\_MUTE line goes high. Note that the TBA0M0x will not key the transmitter if the receiver's CTCSS is defeated (CD\_OUT is low) to prevent receiver channel noise being transmitted.

From the description above of the keytone/function tone detection it can be seen that keying from line has priority over Repeater Mode keying and audio gating.

## 4.3 Alarm Monitoring

The TBA0M0x microprocessor monitors eight alarm sources:

- Two external closure alarms: Alarm InputA and InputB
- Four external closure alarms: Alarm Input0 to Input3
- Low voltage
- Line fail

When an alarm is triggered it is latched, as indicated by the corresponding LED on the front panel. If the TBA0M0x is keying the transmitter or sending receiver audio to the line the latched alarm is ignored. Once the TBA0M0x re-enters the idle state the latched alarms are actioned. The microprocessor reads the EEPROM to determine what tone sequence the user programmed and instructs the DSP accordingly. If the tone sequence is to be sent to the transmitter, it is keyed 500ms before the tones are generated. Additionally the user may program any of the 4 auxiliary output ports as a response to an alarm event. The microprocessor will activate (pull low) these outputs if enabled. If several alarms are latched together they are actioned in the following order of priority:

- External closure alarms: Alarm Input0 to Input3
- External closure alarm: Alarm InputA
- External closure alarm: Alarm InputB
- Low voltage
- Line fail

If the programmed alarm action is a pip tone, the microprocessor will instruct the DSP to append 200ms burst of 600Hz tone to each transmission (to line and/or radio).



**Note** Sub-rack alarms (Alarm Input A, Alarm Input B, Low battery or Line fail) cannot be re-triggered until they are cleared. The four external closure alarms however will resend any user programmed tone sequence if retriggered when already latched.

### 4.3.1 Alarm Triggers

The alarms are triggered according to their type.

#### External Closure Alarms (Auxiliary Input Alarms)

The 8 bit input latch (IC202) is sampled every 50ms. If two successive samples are the same value then the state of the closure alarms is tested (this has the effect of debouncing the alarm inputs). If any alarm is low, it is then

latched. Note that Alarm InputA and InputB must be active (low) for two seconds before they are latched.

**Low Voltage Alarm** The power supply line voltage is measured by the A/D converter (IC208) every 50ms. If the voltage is below the programmed alarm threshold ( $\pm 0.05V$ ) for more than 25 seconds of a 30 second sampling period, the alarm is latched. The long sampling period allows for load fluctuation effects on the supply.

**Line Fail Alarm** If no keying from line occurs within the period programmed by the user from the Tone Remote Programming Application, the microprocessor latches this alarm, saves the mode status and puts the TBA0M0x into Repeater Mode. Note that programming zero as the line fail time disables this alarm.

**Table 4.1 Alarm Summary Table**

| Priority | Alarm Name             | Trigger type  | Re-triggerable when latched | LED colour |
|----------|------------------------|---|-----------------------------|------------|
| 1        | Alarm Input0 to Input3 | External closure. Sampled every 50ms                                    | Yes                         | Green      |
| 2        | Alarm InputA           | External closure. Sampled every 50ms with a 2s delay.                   | No                          | Red        |
| 3        | Alarm InputB           |   |                             |            |
| 4        | Low voltage            | Voltage must be below the programmed threshold for 25s of a 30s period. | No                          | Red        |
| 5        | Line fail              | Programmable non-activity time period                                   | No                          | Red        |

## 4.4 Confirmations

The TBA0M0x microprocessor also monitors eight non-alarm triggers known as Confirmations:

- Power-up
- Channel change
- Up to six user defined function tone inputs

The TBA0M0x microprocessor responds to a confirmation trigger in the same way as it does to an alarm trigger – depending on what has been programmed into the EEPROM, a tone sequence may be sent, an auxiliary output enabled and/or a pip tone enabled. These are all actioned by the microprocessor with the same rules as for alarm triggers. The only difference is that there are no LEDs associated with confirmations.

If several confirmations are triggered together they are actioned in the following order of priority: Power-up, Channel change and then User Confirmation 0 to 5. If several alarms and confirmations are triggered

together the Power-up confirmation, if enabled, is always actioned first, followed by any alarms and then any other confirmations, both in their normal priority order.



**Note** Confirmations will re-send any user programmed tone sequence if re-triggered.

## 4.5 Clearing Alarms and Confirmations

The alarms can be cleared by either pressing both front panel switches together or sending the TBA0M0x a correctly programmed (“Clear Alarms”) function tone. All alarms are cleared together. Clearing alarms turns off all LEDs, cancels any associated pip tones and resets auxiliary outputs. If an alarm condition is still valid when it is cleared, it will be re-latched and the user-programmed action will be executed. If required, pip tones can be cleared separately (leaving alarms latched) by using a “Clear Alarm/Confirmation Pip tones” function tone.

When the Line fail alarm is cleared, the TBA0M0x will revert to the mode it was in (Base Station or Repeater) before the alarm was triggered. A keying sequence from line can also clear this alarm in the same way except that the pip tone will not be cleared if used by other latched alarms. Line fail is the only alarm that can be cleared individually in this way.

Confirmations can not be cleared by a single command like the Alarms. Confirmation pip tones are cancelled by using a “Clear Alarm/Confirmation Pip tones” programmed function tone and the auxiliary outputs are individually reset by using a “Turn OFF Auxiliary output (x)” function tone.

It is possible to have more than one Alarm or Confirmation using the pip tone. In this situation the clearing behaviour must be carefully considered:

- Line Fail Pip – Cleared by line keying-sequence only if pip tone is not ‘active’ for other Alarms and/or Confirmations.
- Alarm Pips (including Line Fail) – Cleared by “Clear Alarms” command only if Confirmation pips are not ‘active’. Always cleared by “Clear Alarm/Confirmation Pip tones” command.
- Confirmation Pips – Cleared by “Clear Alarm/Confirmation Pip tones” command.

Additionally, it is also possible to have a single Auxiliary output assigned to more than one Alarm or Confirmation. However, be aware that any command that resets auxiliary outputs, such as “Clear Alarms” or “Toggle Auxiliary Output (x)”, will not make any check for multiple use – auxiliary outputs will be reset regardless.

## 4.6 Voting Tone Operation

When the TBA0M0x is programmed to generate a tone on idle, the microprocessor monitors the receiver Mute-In signal. When it is high (receiver muted) the DSP is instructed to generate a voting tone to Line-Out. When receiver Mute-In is low the voting tone is turned off. To prevent false detection of the idle tone at the far end voting equipment, the DSP filters energy at the idle tone frequency from the receiver audio transmitted to Line-Out.

If the TBA0M0x is programmed to generate a Sliding Voting Tone (Simoco compatible) the microprocessor reads the receiver RSSI level every 6ms using the A/D converter and sends this value to the DSP. The DSP generates a voting tone to Line-Out. The tone frequency is proportional to the RSSI level. To prevent incorrect operation of the far end voting equipment, the DSP low pass filters the receiver audio transmitted to Line-Out.

Figure 4.2 Signal Flow

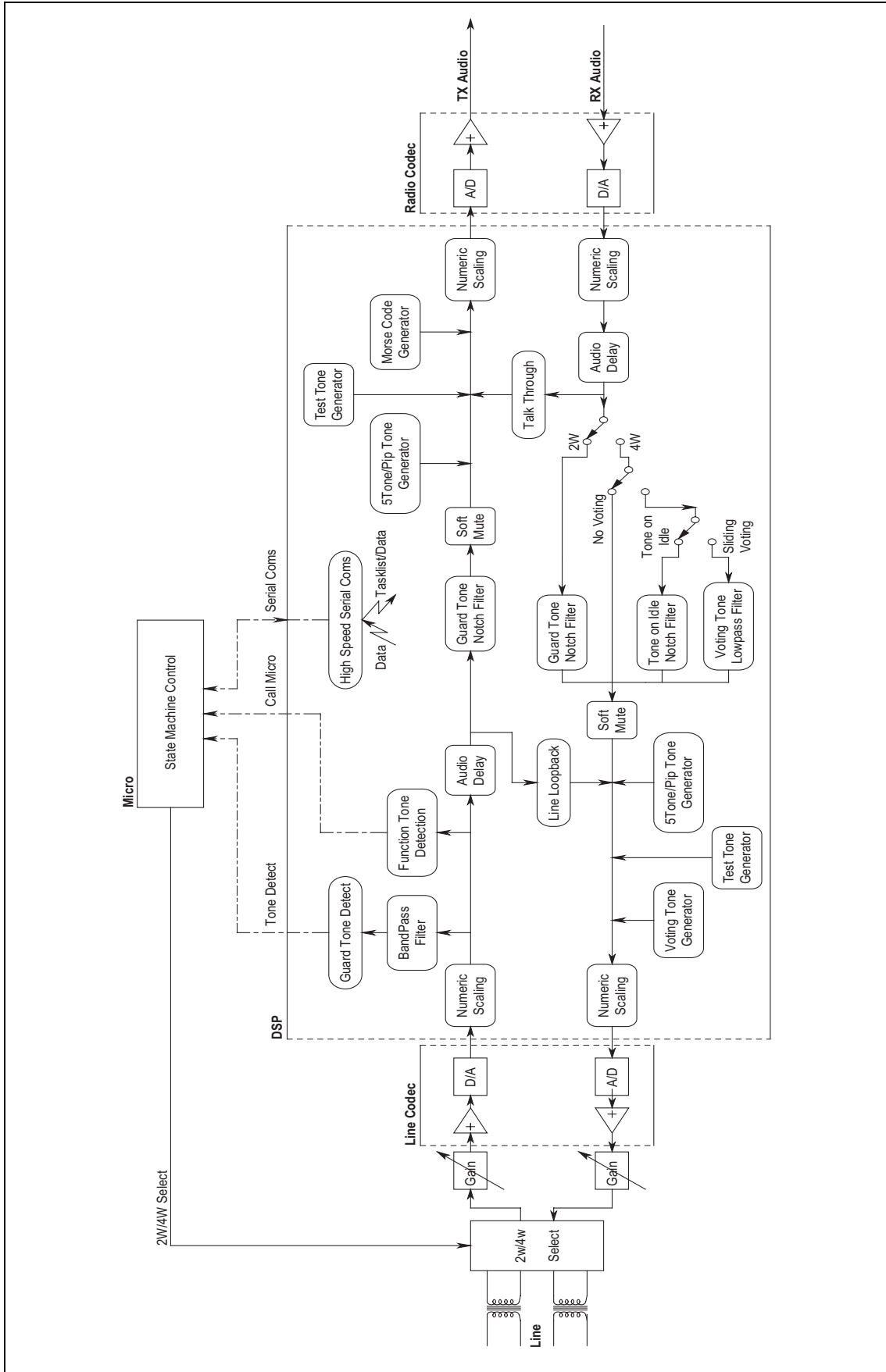

## 4.7 Use of Test Microphone

The TBA0M0x test microphone is used to communicate both on air to radios and down the line to dispatch consoles. It plugs into the RJ11 connector on the front panel. It is electrically connected in parallel with the receiver (microphone with receiver audio and PTT button with receiver mute).

Most dispatch consoles are equipped with an intercom facility whereby speech can be sent to line without a keytone. This enables the dispatcher to talk to service personnel at the repeater site using the TBA0M0x's built in speaker without broadcasting speech to air. The service personnel can talk back to the dispatcher using the TBA0M0x test microphone (the PTT must be pressed to gate microphone speech).



**Note** If the TBA0M0x is in Repeater Mode, PTT on the test microphone will key up the transmitter and thus broadcast test speech to air.

## 4.8 Test Modes

The TBA0M0x has three test modes to assist with setting levels:

- Test Tone Mode
- Line-In Level Configuration Mode
- Line-Out Level Configuration Mode

Figure 4.3 Mode switching cycle

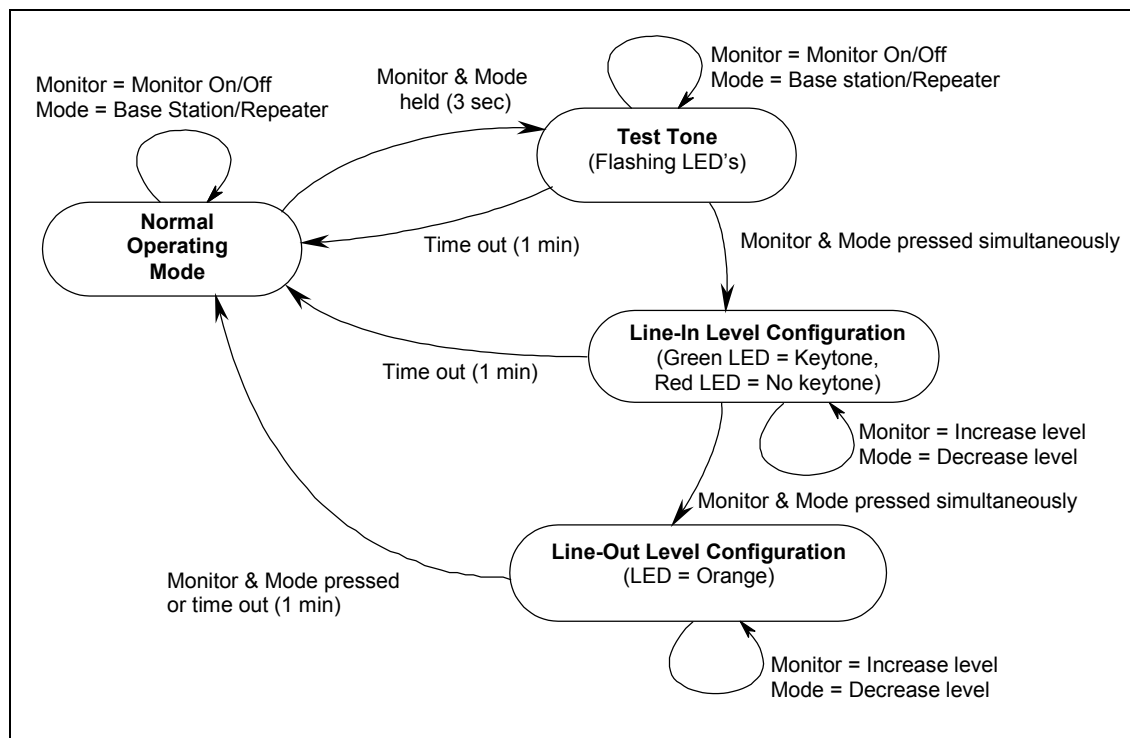

To enter the test modes, press the Monitor and Mode Toggle buttons on the front of the TBA0M0x simultaneously for three seconds. The alarm LEDs will display flashing colours travelling back and forth to indicate Test Tone Mode. The TBA0M0x will key-on the transmitter and encode a 1 kHz test tone to the transmitter for one minute. The test tone can also be heard on the TBA0M0x speaker.

While still in Test Tone Mode, simultaneously pressing the Monitor and Mode Toggle buttons again will change the mode to Line-In Level Configuration Mode. All the LEDs will be on – either entirely red or entirely green.

- Green = Keytone present on Line-In. TBA0M0x will key-on the associated transmitter.
- Red = No keytone present

While still in Line-In Level Configuration Mode, simultaneously pressing the Monitor and Mode Toggle buttons again will change the mode to Line-Out Configuration Mode. To indicate this, all the LEDs will be orange.



**Note** After entering each mode, a one to two second pause is required before attempting the simultaneous press to enter the next mode (or to exit).

While in Line-In or Line-Out Configuration Mode, the Monitor and Mode Toggle buttons operate as ‘gain’ adjust buttons. A press on the Monitor button will increase the Line-In/Line-Out gain and toggle the left alarm LED on or off, indicating a level increase. When the top of the range has



been reached, the LED will no longer toggle (it will stay on). Conversely the Mode Toggle button will decrease the gain and toggle the right alarm LED. When the bottom of the range has been reached, the LED stays on. In both of these modes Line-In audio can be heard on the monitor speaker.

To exit Line-Out Configuration Mode, simultaneously press both buttons again. Alternatively, the unit will automatically return to normal operation mode after one minute. (This occurs in all three test modes).



**Note** These levels are always preserved on exit. Take care not to change them unintentionally during simultaneous button press.



# 5 Before Installing

---

This sections provides some general and advisory information on installing and configuring the TBA0M0x Tone Remote and Alarm Interface.

## 5.1 ESD Precautions



**Important** This equipment contains devices which are susceptible to damage from static charges. You must handle these devices carefully and according to the procedures described in the manufacturers' data books.

We recommend you purchase an antistatic bench kit from a reputable manufacturer and install and test it according to the manufacturer's instructions. [Figure 5.1](#) shows a typical antistatic bench set-up.

You can obtain further information on antistatic precautions and the dangers of electrostatic discharge (ESD) from standards such as ANSI/ESD S20.20-1999 or BS EN 100015-4 1994.

**Figure 5.1** Typical antistatic bench set-up

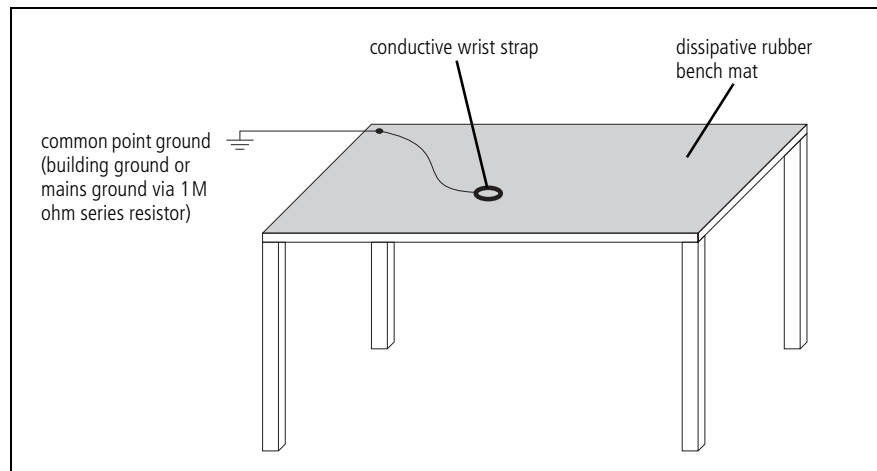

## 5.2 Installing the TBA0M0x



**Warning!!** This equipment must only be installed and maintained by service personnel.

The TBA0M01 and TBA0M02 are both 2U subracks designed to fit into a standard 19 inch rack or cabinet, just above or below the base station using M6 screws, and require a pozidriv PZ3 screwdriver.

It is beyond the scope of this manual to provide comprehensive information regarding the installation of the base station. If this is required please refer to the relevant base station Installation and Operation Manual.

Refer also to the TBA0M01/2 Tone Remote and Alarm Interface PCB Information Package for the parts lists, grid reference index and circuit diagrams which provide detailed information on identifying and locating components and test points on the main circuit board.



**Note** Unless otherwise specified, the term “Tone Remote Programming Application” used in this manual refers to version 1.08 or later.

## 5.3 Dispatch Consoles

Third party dispatch consoles may vary in tone levels and duration. The values may be preset or user programmed. These need to be checked (allowing for line loss) when setting up a new system, or when replacing a console to allow correct setup of the tone remote.

Refer also to the introduction of [Section 8](#) and the wiring of the RJ45 plug in [Section 8.1](#).

## 6 Interfacing the TBA0M0x with the TB7100

The TBA0M0x tone remote can be used with the TB7100 base station. The configuration of the system is best achieved in stages:

1. Cable connection between TBA0M0x and TB7100
2. TB7100 system interface board links
3. TB7100 Programming
4. TBA0M0x Programming
5. Level Configuration (See [Section 8](#))

### 6.1 Cable connection between TBA0M0x and TB7100

Figure 6.1 TBA0M0x to TB7100 Cable connection

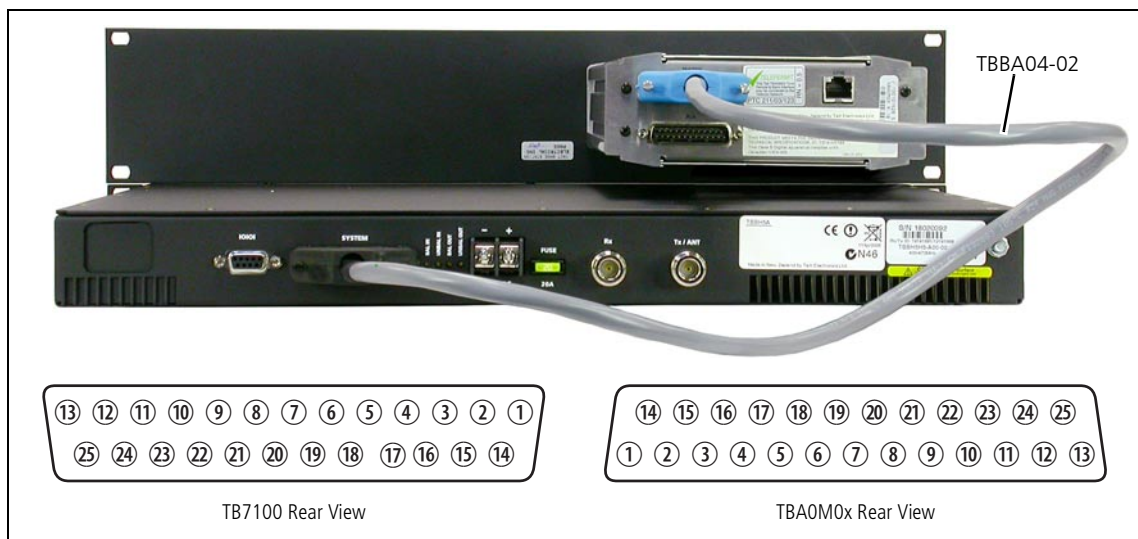

A special cable (TBBA04-02) is required between the TBA0M0x and the TB7100, the blue end being plugged into the TBA0M0x. [Table 6.1](#) shows the pin allocations.

For alternative pin allocations, see [Section 7.6](#). This section covers TBA0M0x to/from TB8100 I/O, however, it can be used as a guide for TB7100 systems. For further assistance, please contact Tait Technical Support.

Most of the TBA0M0x and TB7100 input/outputs are also available on the TBA0M0x Aux connector (see [Section 6.5](#)). For systems with other external equipment requiring connection to the Aux connector, please contact Tait Technical Support.

**Table 6.1 TBBA04-02 (TBA0M0x to TB7100 cable) pin allocations**

| TBA0M0x Connector (Blue) |                    | TB7100 System Connector (Black) |                         | Comment   |
|--------------------------|--------------------|---------------------------------|-------------------------|---|
| Pin                      | Function           | Pin                             | Function                |   |
| 1                        | Rx in +            | 1                               | Rx Line Output +        | Balanced 600Ω output from the TB7100. Not used by the TBA0M0x but can be routed to the TBA0M0x Aux Connector.                             |
| 2                        | Rx in –            | 4                               | Rx Line Output –        |   |
| <b>3<sup>a</sup></b>     | <b>Rx audio</b>    | <b>24</b>                       | <b>Rx audio output</b>  |   |
| 4                        | Ground             |                                 |                         | No connection required  |
| 5                        | Tx audio           | 11                              | Tx audio input          | High Z unbalanced input to the TB7100. Direct connection from TBA0M0x Aux connector (Pin 5)   |
| <b>6</b>                 | <b>Tx out +</b>    | <b>5</b>                        | <b>Tx Line Input +</b>  |   |
| <b>7</b>                 | <b>Tx out –</b>    | <b>8</b>                        | <b>Tx line Input –</b>  |   |
| 8                        | RSSI               | 9                               | RSSI                    | Used if voting is required  |
| <b>9</b>                 | <b>Rx gate</b>     | <b>14</b>                       | <b>Rx Gate</b>          |   |
| <b>10</b>                | <b>Tx key</b>      | <b>15</b>                       | <b>Tx Key</b>           |   |
| 11                       | Alarm Input A      | 10                              | Tx digital in/out 1     | Used if a TB7100 event/status (output) is required to trigger a TBA0M0x alarm. <sup>b</sup>   |
| 12                       | Alarm Input B      | 19                              | Rx digital in/out 1     | Used if a TB7100 event/status (output) is required to trigger a TBA0M0x alarm. <sup>b</sup>   |
| <b>13</b>                | <b>+13.8V</b>      | <b>25</b>                       | <b>13.8V output</b>     |   |
| 14                       | Channel select 0   | 2                               | Tx/Rx Digital in 1      | Used for selection of up to 2 channels.   |
| 15                       | Channel select 1   | 3                               | Tx/Rx Digital in 2      | Used for selection of up to 4 channels.   |
| 16                       | Channel select 2   | 6                               | Tx/Rx Digital in 3      | Used for selection of up to 8 channels.   |
| 17                       | Channel select 3   | 7                               | Tx/Rx Digital in 4      | Used for selection of up to 16 channels.  |
| 18                       | Channel Select 4   | 19                              | Rx digital in/out 1     | Can be used for selection of up to 32 channels.   |
| 19                       | Channel Select 5   |                                 |                         | No connection. Could be used for one of the TB7100 digital inputs. <sup>c</sup>   |
| 20                       | Channel Select 6   |                                 |                         | No connection. Could be used for one of the TB7100 digital inputs. <sup>c</sup>   |
| 21                       | Auxiliary Output 1 |                                 |                         | No connection. This connection could be used if a TB7100 action is required to be triggered by the TBA0M0x/dispatch console. <sup>c</sup> |
| 22                       | Auxiliary Output 0 |                                 |                         | No connection. This connection could be used if a TB7100 action is required to be triggered by the TBA0M0x/dispatch console. <sup>c</sup> |
| 23                       | CTCSS Defeat       |                                 |                         | No connection. Could be used as a TB7100 digital input. <sup>c</sup>  |
| 24                       | Coax relay driver  | 23                              | Digital output/Tx relay | Not required for tone remote operation. This TB7100 output is connected to the TBA0M0x Aux connector (Pin 2).                             |
| <b>25</b>                | <b>Ground</b>      | <b>13</b>                       | <b>Ground</b>           |   |

a. The bold shaded rows are connections that are required if making a custom cable.

b. See the TB7100 installation and operation manual for details.

c. A custom cable will be required. See the TB7100 installation and operation manual for details.

### 6.1.1 Power Supply

The power for the TBA0M0x is drawn from the TB7100 through the 25 way connector as described in [Table 6.1](#).

## 6.2 TB7100 system interface board links

The TB7100 system interface board, found inside the TB7100, has link settings which allow the configuration of audio paths, control signals, digital I/O, data, and fan behaviour.

For operation with the TBA0M0x tone remote, no change is required to the default factory positions of these links.

The table below shows the relevant links and their required positions (factory default).

**Table 6.2 TB7100 System Interface links**

| Link | Position | Function  |
|------|----------|---|
| J400 | 1-2      | External PTT signal to transmitter  |
| J500 | 2-3      | De-emphasis (Line out from Rx)  |
| J501 | 2-3      | Pre-emphasis (Line In to Tx)  |
| J502 | 1-2      | External audio line in to Tx  |
| J503 | 2-3      | Rx Audio sent to balanced and unbalanced external outputs   |
| J507 | 2-3      | Tx audio directed to tap point AUDIO_TAP_IN   |
| W300 | 1-2      | Optional. When fitted, Tx digital in/out 1 is connected to Rx digital in/out 1, allowing both modules to respond to the same digital input. Could be used to provide channel select line 4 for the TBA0M0x. |

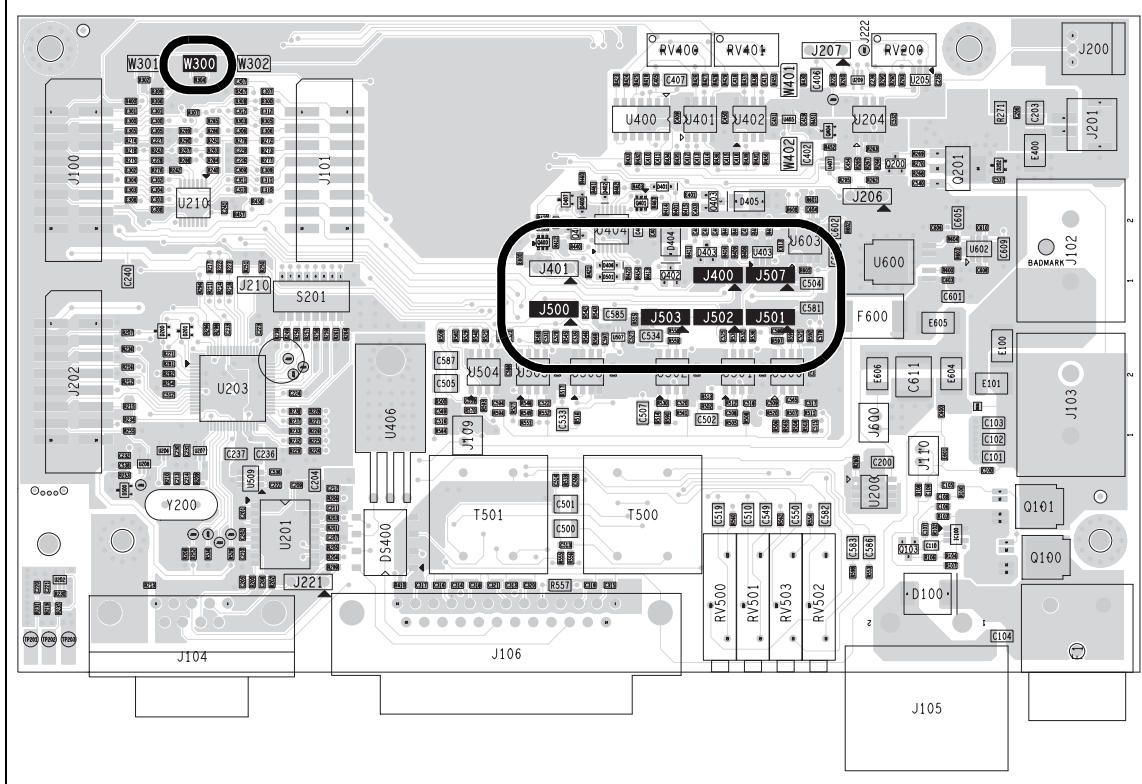

## 6.3 TB7100 Programming

The following describes how to program the TB7100 for operation with the tone remote, and in particular the channel select functionality. The default settings for the Rx Gate and Tx Key control lines will work with the TBA0M0x.



**Note** Each TB7100 module (Tx and Rx) will need to be programmed separately.

From within the TB7100 programming application navigate to the Programmable I/O form. The form includes a table showing all the digital I/O lines. The signal lines available for channel selection are the first five pins listed in the table (AUX\_GPI1 to AUX\_GPI3, AUX\_GPIO4 and AUX\_GPIO5). Depending on the particular system configuration some or all of these signal lines may be used for channel select. However, the lines must be used sequentially and must start with AUX\_GPI1. Additionally, when AUX\_GPIO5 is used (if 32 channel select is required), Link W300 must be fitted on the system interface board (see [Section 6.2](#)).

Steps for setting up channel selection:

1. Determine the number of signal lines required. Note that the TBA0M0x uses binary format for channel select.
2. Set the signal direction of each line to INPUT.
3. Label the signal lines as desired.
4. Click on the ACTION field and use the drop-down menu to select BCD Pin. Use BCD Pin 0 for signal line AUX\_GPI1, BCD Pin 1 for AUX\_GPI2, and similarly for each line.
5. Set the logic of each line to High.
6. Set the Debounce on each line to 5ms.

[Figure 6.2](#) shows an example in which TB7100 inputs AUX\_GPI1 to AUX\_GPI3 are configured as channel select lines.



Figure 6.2 Sample Channel Select Line programming

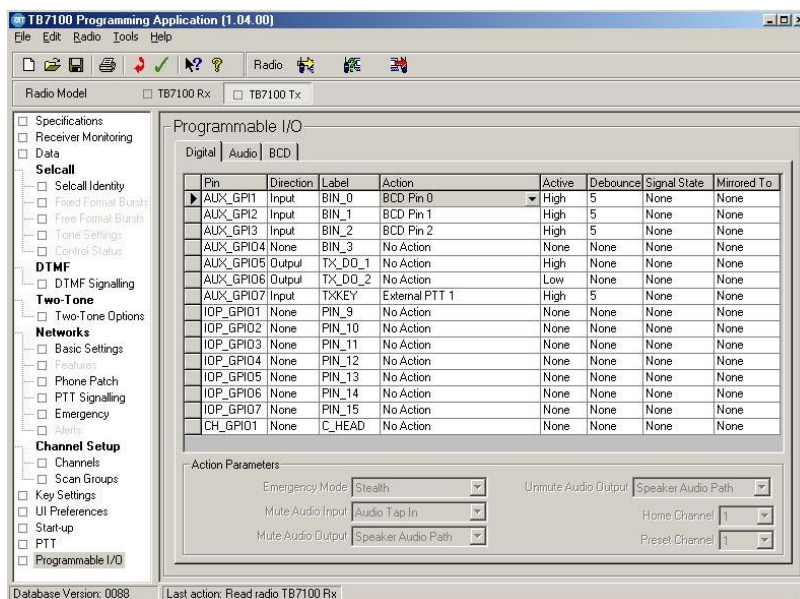

7. Click on the BCD tab.
8. Select BIN from the BCD/BIN Operation drop down menu.
9. Select Channel ID from the BCD Channel Selection



**Note** If this option is not available, or if Record Number is selected, the TBA0M0x must be programmed accordingly. See Section 6.3.1.

Figure 6.3 Programmable I/O BCD tab

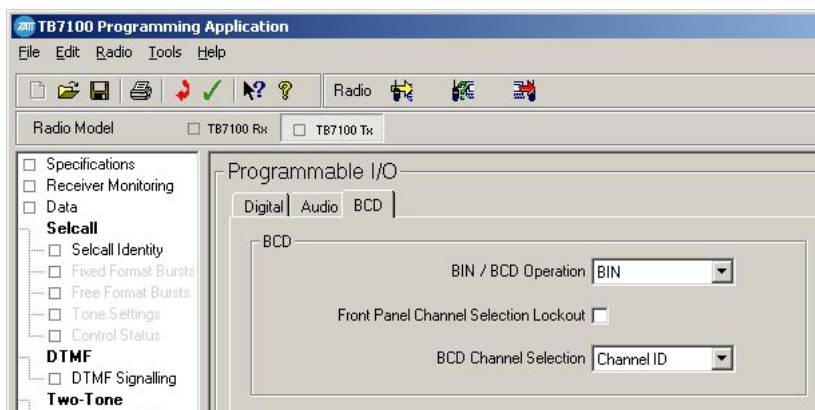

### 6.3.1 TB7100 Programming Application v1.08 and earlier

Earlier versions of the TB7100 programming application do not have the option to select the channel by Channel ID. Channel selection using external signal lines (BCD or binary) selects a channel number corresponding to the record number in the channel table – **NOT** the

channel ID. That is, if channel 4 is selected using the tone remote the actual channel selected will be the fourth record in the channel table. The front panel channel number displayed will be the channel ID.

If it is required that the channel displayed reflect the binary channel number selected by the tone remote then ensure that the TB7100 channel IDs are sequential and start at channel 0 (whether or not channel 0 is actually used).

Alternatively the channels programmed into the tone remote can be set so that the dispatch console channel select matches the TB7100 channel display. For example, based on the channel table shown below, the dispatch console and the TB7100 can be programmed with the same channel numbers but because the binary channel select is based on the channel record in the table, the tone remote is programmed for record numbers 0 to 3.

**Figure 6.4 Sample configuration of Channel Selection**

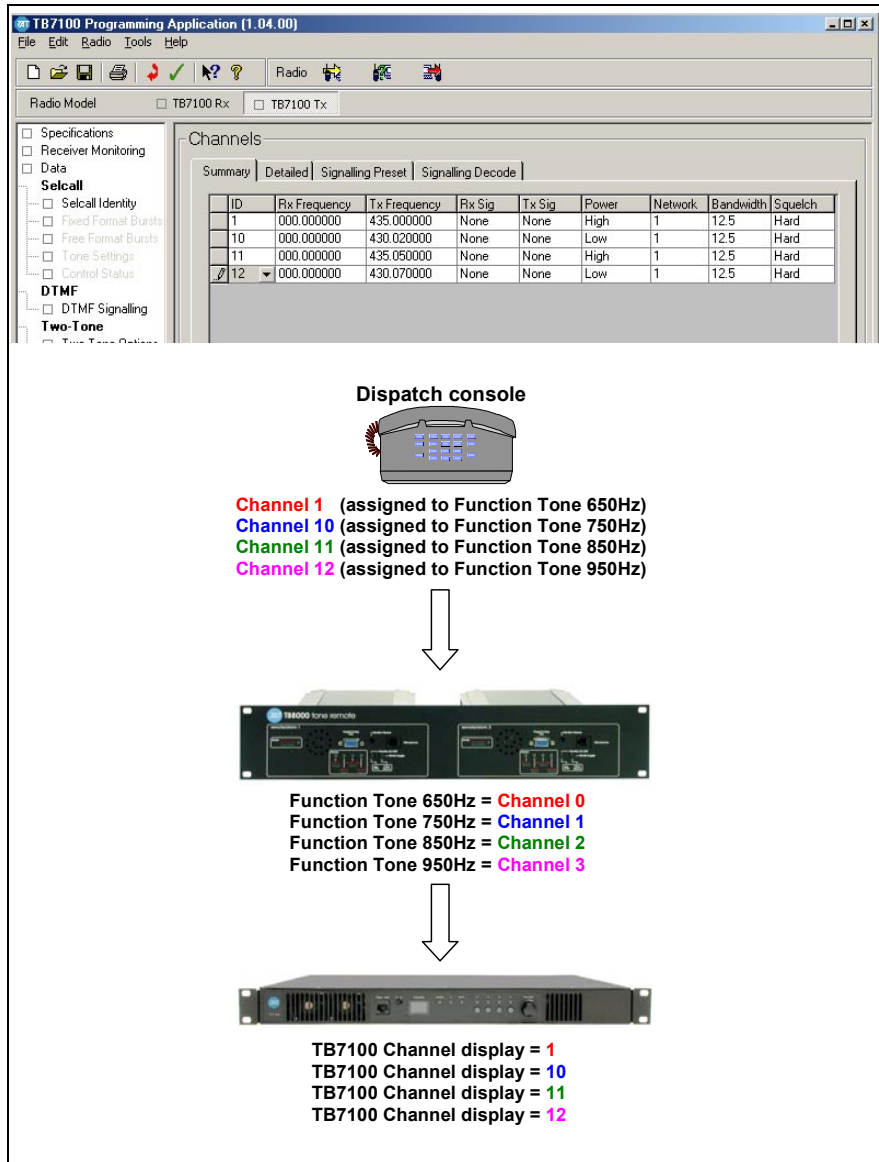

## 6.4 TBA0M0x Programming

This section describes key settings required when programming the tone remote for operation with the TB7100.



**Note** Unless otherwise specified, the term “Tone Remote Programming Application” used in this manual refers to version 1.08 or later.

The two settings that must to be properly set are the channel select output characteristic and the RSSI signal characteristic (if voting is required).

- On the General Settings Form, ensure that the Use Momentary Channel Select option is *not* checked.
- If Sliding Voting Tone or Simoco/Philips Standard is used, adjust the RSSI signal characteristic as follows.
  1. On the Voting/Levels Form, use the drop down menu from the Characteristic field and select User Defined.
  2. Adjust the curve using the Voltage and Signal Level adjustments, so that the tone remote RSSI curve matches the TB7100 curve, as shown in [Figure 6.5](#).

**Figure 6.5 Programming RSSI Signal Strength**

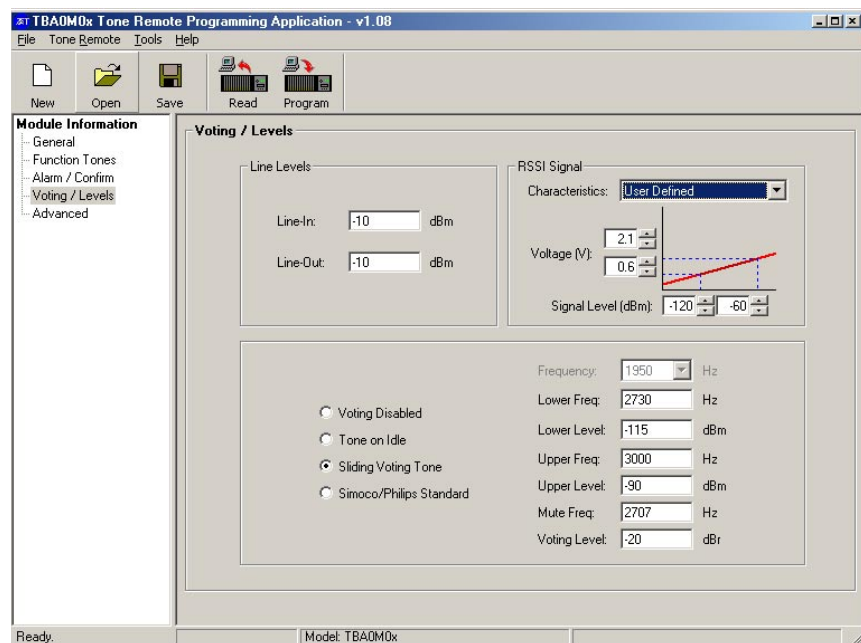

| RF Signal Strength | RSSI Voltage |
|--------------------|--------------|
| -120 dBm           | 0.6V         |
| -60 dBm            | 2.1V         |

## 6.5 The Aux Connector

Figure 6.6 TBA0M0x Aux connector

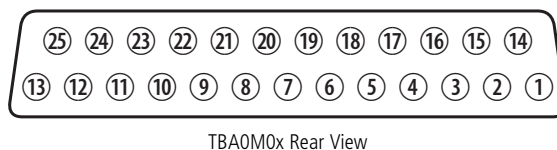

The Aux connector not only provides access to the TBA0M0x I/O, but also allows connection to the TB7100 system interface so that communication with the base station I/O is still possible even when the TBA0M0x is connected to the base station. The most commonly used I/O is provided by the default pin allocations on the Aux Connector.

### 6.5.1 Default Pin Allocation

- Direct connection to or from the TB7100 base station for:
  - Coax relay driver
  - RSSI
  - Tx Audio (high impedance input, unbalanced)
  - Rx Audio (high impedance output, unbalanced)
  - Tx Digital In/Out 1 and 2
  - Rx Digital In/Out 1 and 2
  - +13.8V supplied by the TB7100. Current limited to 1.5A.
- All TBA0M0x Auxiliary outputs
- Tx key output from TBA0M0x
- Rx Gate input to TBA0M0x
- Channel select output from TBA0M0x (128 channel binary format)
- TBA0M0x Alarm Inputs 0 and 1
- A Serial Comms connection.

For alternative pin allocations, see [Section 7.8.3](#). This section covers TBA0M0x to/from TB8100 I/O, however, it can be used as a guide for TB7100 systems. For further assistance, please contact Tait Technical Support.

**Table 6.3 Default Aux connector pin allocations**

| Pin | Name                | TBA0M0x links and/or switch settings | Signal Type      | Notes <sup>a</sup>                      |
|-----|---------------------|--------------------------------------|------------------|---|
| 1   | +13.8V              |                                      | Power output     | Current limited to 1.5A by the TB7100   |
| 2   | Coax relay driver   | R606A and R607A                      | Output           | From TB7100 Tx relay (open collector)   |
| 3   | RSSI                |                                      | DC signal output | From TB7100                             |
| 4   | Auxiliary Output 0  | R610A                                | Output           | From TBA0M0x. Open collector            |
| 5   | Tx Audio In         | R611A                                | Audio input      | To TB7100. High impedance unbalanced    |
| 6   | Rx Audio Out        | R612B and SW600 switch 4 ON          | Audio output     | From TB7100. High impedance unbalanced. |
| 7   | Tx Digital In/Out 1 | R643 and R605A                       | Output           | From/To TB7100 Digital In/Out 1         |
| 8   | Alarm 0 In          | R615B (R605B not fitted)             | Input            | To TBA0M0x Alarm input 0 (5V logic)     |
| 9   | Auxiliary Output 2  | R616B and SW601 switch 4 ON          | Output           | From TBA0M0x. Open collector            |
| 10  | Rx Digital In/Out 2 | R644 and R604A                       | Output           | To/From TB7100 Digital In/Out 2         |
| 11  | Alarm 1 In          | R618B (R604B not fitted)             | Input            | To TBA0M0x Alarm input 1 (5V logic)     |
| 12  | Auxiliary Output 3  | R619B and SW601 switch 2 ON          | Output           | From TBA0M0x. Open collector            |
| 13  | CTCSS Defeat        | R621B                                | Output           | From TBA0M0x. Open collector            |
| 14  | Tx Key Out          |                                      | Output           | From TBA0M0x. Open collector            |
| 15  | Channel Select 0    | DIP SW600 switch 5 ON                | Output           | From TBA0M0x. 5V Logic (Active high)    |
| 16  | Channel Select 1    | DIP SW600 switch 6 ON                |                  |   |
| 17  | Channel Select 2    | DIP SW600 switch 7 ON                |                  |   |
| 18  | Channel Select 3    | DIP SW600 switch 8 ON                |                  |   |
| 19  | Channel Select 4    | DIP SW601 switch 1 ON                |                  |   |
| 20  | Channel Select 5    | R628B and SW601 switch 3 ON          |                  |   |
| 21  | Channel Select 6    | R629B and SW601 switch 5 ON          |                  |   |
| 22  | Auxiliary Output 1  | R630A                                | Output           | From TBA0M0x. Open collector            |
| 23  | Rx Gate In          |                                      | Input            | To TBA0M0x. 5V logic                    |
| 24  | Serial Comms        | DIP SW601 switch 8 OFF (slave)       |                  | Ping-Pong protocol <sup>b</sup>         |
| 25  | Ground              |                                      | Ground           |   |

a. For full specifications see [Section 6.5.2](#).

b. A Serial Comms connection is available. This is a Ping-Pong protocol bus. By linking this connection (and ground) between modules, all the connected modules can be programmed via a RS232 on a single master module. The slave modules must have switch 8 of DIP SW601 switched OFF. The Tone Remote Programming Application will then detect and identify each connected module.

## 6.5.2 Aux Connector I/O specifications

The following tables describe the specifications and ratings of the signals available on the TBA0M0x Aux connector when the TBA0M0x is connected to the TB7100 base station.



### ***Important***

If two different inputs or outputs are used in parallel ensure that the lower rating is used.

For example, the TB7100 Digital Input (max input 2.0V) is driven by the TBA0M0x Auxiliary Output (max input 50V) and also by an external Digital In on the Aux Connector. The maximum voltage input level of the external Digital In must not exceed the 2.0V of the TB7100 Digital Input.

**Table 6.4 Logic signal and supply voltage specifications**

| Name               | Signal path    | Logic levels   | Ratings  |
|--------------------|----------------|--|--|
| +13.8V             | TB7100 output  | —  | Max 1.5A. Fused on TB7100  |
| Alarm In           | TBA0M0x input  | $\geq 3.5V$ (de-activated)<br>$\leq 1.5V$ (activated)                  | Max input voltage = 5V   |
| Aux Channel Select | TB7100 input   | $\geq 2.0V$ (de-activated)<br>$\leq 0.8V$ (activated)                  | RC, and diode clamps to 3.3V and ground<br>Logic sense can be inverted by TB7100 programming |
| Auxiliary Output   | TBA0M0x output | open collector<br>0V = active  | Max applied voltage = 50V<br>Max sink current = 100mA  |
| Channel Select     | TBA0M0x output | 5V CMOS<br>5V = active   | Max applied voltage = 20V<br>Max sink current = 20mA   |
| Coax relay driver  | TB7100 output  | open collector<br>< 0.4V = active                                      | Max applied voltage = 30V<br>Max sink current = 250mA  |
| CTCSS defeat       | TBA0M0x output | open collector<br>0V = active  | Max applied voltage = 50V<br>Max sink current = 250mA  |
| Digital In         | TB7100 input   | $\geq 2.0V$ (de-activated)<br>$\leq 0.8V$ (activated)                  | RC, diode clamps to 3.3V and ground<br>Logic sense can be inverted by TB7100 programming     |
| Digital Out        | TB7100 output  | High $\geq 3.1V$ (no load)<br>Low < 0.6V (10mA sink)                   | Pull up to 3.3V via 33k $\Omega$   |
| RSSI               | TB7100 output  | DC level range<br>Offset 600mV, then 25mV/dB<br>from -120dBm to -50dBm | 1k $\Omega$ output impedance   |
| Rx Gate In         | TBA0M0x input  | 5V logic<br>0V = audio   | Max input voltage = 50V  |
| Rx Gate Out        | TB7100 output  | open collector<br>< 0.4V = active                                      | Max applied voltage = 30V<br>Max sink current = 250mA  |
| Shift Mix          | TBA0M0x output | open collector<br>0V = active  | Max applied voltage = 50V<br>Max sink current = 250mA  |
| Tx Key In          | TB7100 input   | $\leq 2.0V$ (TXKEY = activated)<br>$\geq 5.0V$ (TXKEY = de-activated)  | Input resistance $\geq 10k\Omega$<br>Internal pull up to 9V<br>Max external pull up = 20V    |
| Tx Key Out         | TBA0M0x output | open collector<br>0V = active  | Max applied voltage = 50V<br>Max sink current = 250mA  |

**Table 6.5 Audio Signal Specifications**

| Name         | Signal path                     | Specifications  |
|--------------|---------------------------------|---|
| Rx Audio In  | TBA0M0x input                   | Unbalanced high impedance input (>10kΩ). Level required for correct operation of TBA0M0x is 230mV <sub>rms</sub>  |
| Rx Audio Out | TB7100 output                   | Unbalanced 220Ω output. The output level is adjustable 220mV <sub>pp</sub> to 3V <sub>pp</sub> into 10kΩ  |
| Rx Out+      | TB7100 output                   | Balanced 600Ω audio interface. The output level is adjustable -20dBm to +3dBm for 60% modulation. Not used by the TBA0M0x.  |
| Rx Out-      |                                 |   |
| TX Audio in  | TB7100 input                    | Unbalanced high impedance input (>10kΩ). The input level is adjustable 220mV <sub>pp</sub> to 3V <sub>pp</sub> .  |
| Tx Out-      | TBA0M0x output/<br>TB7100 input | Parallel connection to the 600Ω balanced Tx Audio path between the TBA0M0x and the TB7100. Consequently if this audio is to be accessed on the Aux connector, this must be done using a high impedance load, thereby not upsetting the match/levels between the TBA0M0x and the base station. Output level -4.4dBm (when the Line-In level is properly set-up or when the TBA0M0x is in Test Tone Mode) |
| Tx Out+      |                                 |   |



## 7 Interfacing the TBA0M0x with the TB8100

---

This section of the manual describes how to configure the TBA0M0x with a TB8000 series base station, and test that it is functioning correctly.

### 7.1 Connecting to a TB8100 Base Station

The TBAA04-08 25-way cable is used to connect a TBA0M0x module to a TB8100 reciter that has been fitted with a system interface board. The system interface board is an optional board that provides the links between the reciter's internal circuitry and external equipment.

The TBA0M0x is compatible with two of the system interface boards available at the time of publication:

#### Standard

The standard system interface board is fitted to reciters bearing the product code TBA4xxx-0A0x or TBA5xxx-0B0x. If purchased separately, it has the product code TBA10A0.

#### Isolated

This system interface board is fitted to reciters bearing the product code TBA4xxx-0B0x or TBA5xxx-0A0x. If purchased separately, it has the product code TBA10B0. It is the same as the standard model, except that the balanced audio interfaces are electrically isolated.

Each of these boards is fitted with a 25-way female D-range connector and an auxiliary DC input connector. The TBA0M0x is supplied with DC power via the +AUX\_V pin (pin 13) of the 25-way connection from the system interface board (see [Section 7.2](#) below).

[Figure 7.1](#) below identifies the connections at the rear of a dual base station

**Figure 7.1 TBA0M0x to TB8100 cable connection**

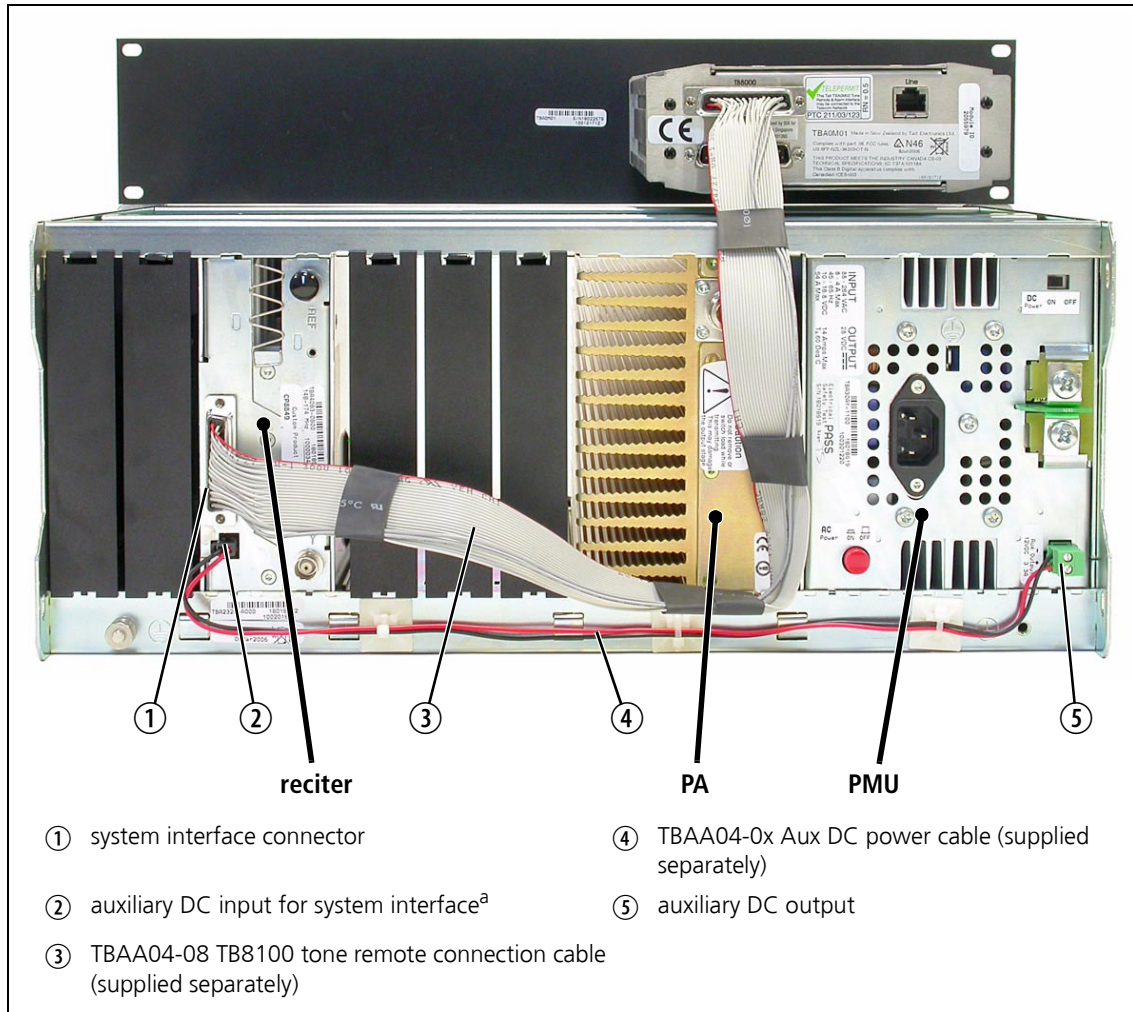

- ① system interface connector
- ② auxiliary DC input for system interface<sup>a</sup>
- ③ TBAA04-08 TB8100 tone remote connection cable (supplied separately)
- ④ TBAA04-0x Aux DC power cable (supplied separately)
- ⑤ auxiliary DC output

a. Older system interface boards use a 4-way connector, while the TaitNet RS-232 board and all other boards manufactured after March 2005 use the 2-way connector shown in the photograph. Refer to the TB8100 Installation and Operation Manual for more details.

## 7.2 Power supply

The DC power supply for the TBA0M0x is provided by the 40 W Auxiliary Power Supply (13.8V option) which must be fitted to the TB8100 Power Management Unit (PMU). This power supply is current limited to 3A and is available on the auxiliary DC output connector on the rear panel of the PMU (item ⑤ in Figure 7.1). By linking this output to the auxiliary DC input on the system interface board (item ② in Figure 7.1), DC is supplied to the +AUX\_V pin of the 25-way system interface connector and hence the TBA0M0x.

The pin allocations for the auxiliary DC output on the PMU are given in the following table. Note that pins 1 to 4 and pins 5 to 8 on this connector are linked. The DC output is 13.8V<sub>DC</sub>. Although this power output is isolated, the negative side of the supply is grounded on the system interface board.

**Figure 7.2 PMU auxiliary DC output pin allocations**

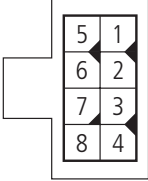
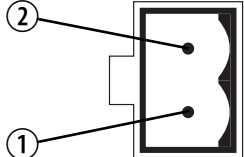
| Before August 2004   | Pin | Description | Links |
|--|-----|-------------|-------|
|  <p>8-way connector – external view</p> | 1   | +V output   | ●     |
|  | 2   | +V output   | ●     |
|  | 3   | +V output   | ●     |
|  | 4   | +V output   | ●     |
|  | 5   | ground      | ●     |
|  | 6   | ground      | ●     |
|  | 7   | ground      | ●     |
|  | 8   | ground      | ●     |
| August 2004 onwards  | Pin | Description |       |
|  <p>2-way connector – external view</p> | 1   | +V output   |       |
|  | 2   | ground      |       |

The pin allocations for the auxiliary DC input on the system interface board are given in the following table. Note that pins 1 & 3 and pins 2 & 4 on this connector are linked.

**Figure 7.3 Reciter system interface board pin allocations**

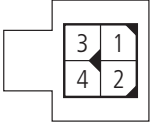
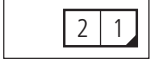
|  | Pin | Description | Links |
|--|-----|-------------|-------|
|  <p>4-way connector – external view</p><br> <p>2-way connector – external view</p> | 1   | +V input    | ●     |
|  | 2   | ground      | ●     |
|  | 3   | +V input    | ●     |
|  | 4   | ground      | ●     |
|  |     |             |       |

## 7.3 TBA0M0x Input/Output Connections

Figure 7.4 TBA0M0x rear panel



The TBA0M0x has a twin 25-way D-range connector at the rear. The top (female) connector is dedicated to base station I/O while the lower 'Aux' (male) connector ports auxiliary I/O.

The Aux connector not only provides access to the TBA0M0x I/O but also allows through connection to a TB8100 system interface (SIF) so that communication with the base station I/O is still possible even when the TBA0M0x is connected to the base station. This means that most of the TB8100 I/O that are normally present on the SIF can be made available on the TBA0M0x Aux connector.

The inter-connection between the TBA0M0x, the base station (via the base station interface connector) and external equipment (via the Aux connector) is configurable by use of link resistors and DIP switches inside the TBA0M0x. To access these, turn the TBA0M0x upside down and remove the two screws towards the rear edge. The cover can then be removed by sliding towards the rear – take care to avoid sharp edges.

Refer to the TBA0M01/2 Tone Remote and Alarm Interface PCB Information Package for the parts lists, grid reference index and circuit diagrams which provide detailed information on identifying and locating components and test points on the main circuit board.

## 7.4 The Base Station Interface Connector

Figure 7.5 Base station interface connector

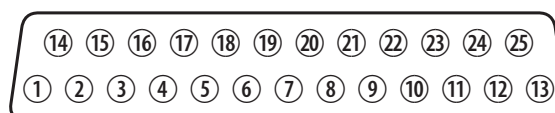

TBA0M0x Rear View

The supplied 25-way cable provides all the connections between the base station interface connector<sup>1</sup> (at the rear of the TBA0M0x) and the TB8100 base station reciter system interface connector (item ① in Figure 7.1). The default pin allocations of this interface includes all the standard I/O required to operate the TBA0M0x with the base station.

### 7.4.1 Default Pin Allocations

Table 7.1 shows the possible pin allocations for the connection between the TBA0M0x and the TB8100. A summary of the default pin allocations (bold shaded cells) follows.

**TBA0M0x Alarm Input A and Input B** have been associated with the TB8100 Digital Outputs (1 and 2). By creating tasks in the TB8100 Service Kit Task Manager, these digital outputs can be enabled and used to trigger the TBA0M0x alarms.

**TBA0M0x Channel select 0 to Channel select 6** have been assigned to the TB8100 Digital Inputs 1 to 7 respectively. This allows for selection of up to 128 channels, but the TB8100 SIF needs to be configured accordingly (See Section 7.5).

**TBA0M0x Auxiliary Outputs 1 and 0** have been assigned to the TB8100 Digital Inputs 8 and 9 respectively. By creating tasks in the Task Manager of the TB8100 Service Kit these digital inputs can be used and to trigger some kind of TB8100 action or response. This is very useful if the base station is required to respond to a TBA0M0x alarm or a dispatch console button press (a TBA0M0x confirmation initiated by a function tone).

**TBA0M0x CTCSS Defeat** has been assigned to TB8100 Digital Input 10. This can be used as an input for an appropriate task.

## 7.5 TB8100 SIF Programming

The TB8100 SIF needs to be configured to allow use of the TB8100 inputs for channel selection.

From within the TB8100 Service Kit navigate to Configure > Base station > System Interface:

- Enable “Channel selection”
- Choose “7 bit selection”
- Select “Binary format”
- Select “Invert”

---

1. The base station interface connector on the rear of the TBA0M0x at time of publishing is labelled ‘TB8000’.

Figure 7.6 TB8100 SIF Pin Allocations

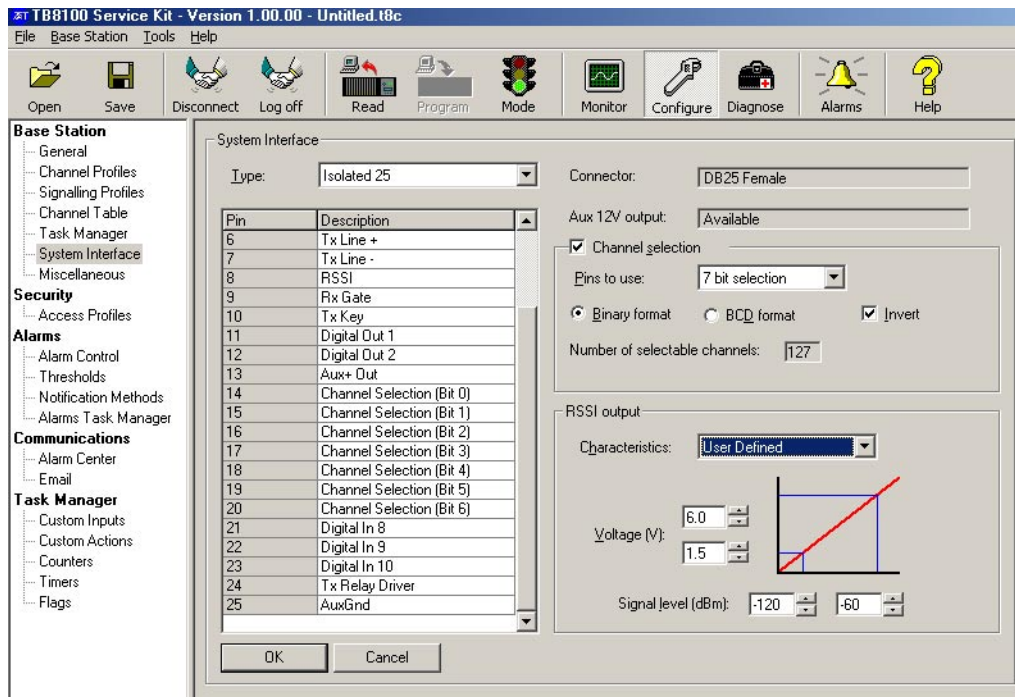

## 7.6 Alternative Pin Allocations

Table 7.1 shows the possible pin allocations for the connection between the TBA0M0x and the TB8100. Following are some of the common custom pin allocations that may be configured. Refer also to the TBA0M01/2 Tone Remote and Alarm Interface PCB Information Package for detailed information on identifying and locating components on the main circuit board.

**Pins 11 and 12:** TB8100 Digital Outputs 1 and 2 can also be associated with TBA0M0x Alarm Input 0 and Input 1.

**Pins 14 to 21:** These pins can be linked directly to pins on the Aux connector thus allowing channel selection to be achieved by external devices. Alternatively by changing the configuration of the TB8100 SIF these lines become simple TB8100 Digital inputs available for use by TB8100 tasks.

**Pins 19 and 20:** Instead of channel select lines they can also be linked to the TBA0M0x Auxiliary Outputs 3 and 2, respectively. The required TB8100 SIF pins must be re-configured so that they become TB8100 Digital inputs. These are then available for use by TB8100 tasks, in response to TBA0M0x alarms and/or confirmations.

For full details of default and alternative pin allocations, see Table 7.1 (Bold shaded cells indicate default configuration).

**Table 7.1 Base Station Interface Connector possible pin allocations**

| Pin | Signal Type<br>(relative to<br>TBA0M0x) | Name                 | Required TBA0M0x links<br>and/or switch settings | Notes  |
|-----|---|----------------------|--|--|
| 1   | Audio Input                             | Rx in+ <sup>d</sup>  |  | <b>Balanced 600Ω. Not used by the TBA0M0x but routed to Aux connector.</b>           |
| 2   |   | Rx in-               |  |  |
| 3   | Audio Input                             | Rx audio             | DIP SW600 switch 4 ON                            | <b>TB8100 receiver audio to TBA0M0x. High impedance unbalanced.</b>                  |
| 4   | Ground                                  | Audio ground         |  |  |
| 5   | Audio Output                            | Tx audio             |  | <b>High impedance unbalanced. Direct connection from Aux connector.</b>              |
| 6   | Audio Output                            | Tx out+              |  | <b>TBA0M0x audio to TB8100 transmitter. Balanced 600Ω.</b>                           |
| 7   |   | Tx out-              |  |  |
| 8   | DC Signal Input                         | RSSI                 |  |  |
| 9   | Input                                   | Rx gate              | DIP SW600 switch 3 ON                            | <b>From TB8100 to TBA0M0x</b>  |
|     |   |                      | R619A, R620B and SW600 switch 3 ON               | From TB8100 (open collector) to TBA0M0x and Aux connector (P100 pin 37)              |
|     |   |                      | R 619A, R620B and SW600 switch 3 OFF             | From TB8100 (open collector) to Aux connector (P100 pin 37) only                     |
| 10  | Output                                  | Tx key               | SW600 switch 2 ON                                | <b>TBA0M0x keying of TB8100</b>  |
|     |   |                      | R616A, R634B and SW600 switch2 ON                | TBA0M0x and Aux connector (P100 pin 34) keying of TB8100 (8V logic)                  |
|     |   |                      | R616A, R634B and SW600 switch 2 OFF              | Aux connector (P100 pin 34) keying of TB8100 (8V logic)                              |
| 11  | Input                                   | Alarm Input A        | R605A  | <b>From TB8100 Digital out 1 (open collector) to TBA0M0x Alarm input A</b>           |
|     |   |                      | R605A and R643                                   | From TB8100 Digital out 1 (open collector) to TBA0M0x and Aux connector (P100 pin32) |
|     |   | Alarm Input 0        | R605B  | From TB8100 Digital out 1 (open collector) to TBA0M0x Alarm input 0                  |
|     |   |                      | R605B and R615B                                  | From TB8100 Digital out 1 (open collector) to TBA0M0x and Aux connector (P100 pin33) |
| 12  | Input                                   | Alarm Input B        | R604A  | <b>From TB8100 Digital out 2 (open collector) to TBA0M0x Alarm input B</b>           |
|     |   |                      | R604A and R644                                   | From TB8100 Digital out 2 (open collector) to TBA0M0x and Aux connector (P100 pin35) |
|     |   | Alarm Input 1        | R604B  | From TB8100 Digital out 2 (open collector) to TBA0M0x Alarm input 1                  |
|     |   |                      | R604B and R618B                                  | From TB8100 Digital out 2 (open collector) to TBA0M0x and Aux connector (P100 pin36) |
| 13  | Power input                             | +13.8V               |  |  |
| 14  | Output                                  | Channel select 0     | DIP SW600 switch 5 ON                            | <b>TBA0M0x Channel Select 0 to TB8100 Digital In 1</b>                               |
|     |   | Aux Channel select 0 | DIP SW600 switch 5 OFF                           | From Aux connector (P100 pin 40) to TB8100 Digital In 1 (5V logic)                   |
|     |   | Digital 1            |  |  |
| 15  | Output                                  | Channel select 1     | DIP SW600 switch 6 ON                            | <b>TBA0M0x Channel Select 1 to TB8100 Digital In 2</b>                               |
|     |   | Aux Channel select 1 | DIP SW600 switch 6 OFF                           | From Aux connector (P100 pin 41) to TB8100 Digital In 2 (5V logic)                   |
|     |   | Digital 2            |  |  |
| 16  | Output                                  | Channel select 2     | DIP SW600 switch 7 ON                            | <b>TBA0M0x Channel Select 2 to TB8100 Digital In 3</b>                               |
|     |   | Aux Channel select 2 | DIP SW600 switch 7 OFF                           | From Aux connector (P100 pin 42) to TB8100 Digital In 3 (5V logic)                   |
|     |   | Digital 3            |  |  |
| 17  | Output                                  | Channel select 3     | DIP SW600 switch 8 ON                            | <b>TBA0M0x Channel Select 3 to TB8100 Digital In 4</b>                               |
|     |   | Aux Channel select 3 | DIP SW600 switch 8 OFF                           | From Aux connector (P100 pin 43) to TB8100 Digital In 4 (5V logic)                   |
|     |   | Digital 4            |  |  |
| 18  | Output                                  | Channel select 4     | DIP SW601 switch 1 ON                            | <b>TBA0M0x Channel Select 4 to TB8100 Digital In 5</b>                               |
|     |   | Aux Channel select 4 | DIP SW601 switch 1 OFF                           | From Aux connector (P100 pin 44) to TB8100 Digital In 5 (5V logic)                   |
|     |   | Digital 5            |  |  |



**Table 7.1 Base Station Interface Connector possible pin allocations (Continued)**

| Pin | Signal Type (relative to TBA0M0x) | Name                             | Required TBA0M0x links and/or switch settings | Notes   |
|-----|-----------------------------------|----------------------------------|---|---|
| 19  | Output                            | <b>Channel select 5</b>          | <b>R603A and SW601 switch 3 ON</b>            | <b>TBA0M0x Channel Select 5 to TB8100 Digital In 6</b>  |
|     |                                   | Aux Channel select 5             | R603A, R628B and SW601 switch 3 OFF           | From Aux connector (P100 pin 45) to TB8100 Digital In 6 (5V logic)                                |
|     |                                   | Digital 6                        | R603B, R619B and SW601 switch 2 OFF           | From Aux connector (P100 pin 37) to TB8100 Digital In 6 (5V logic)                                |
|     |                                   |                                  | R603B, R621A and SW601 switch 2 OFF           | From Aux connector (P100 pin 38) to TB8100 Digital In 6 (5V logic)                                |
|     |                                   | Auxiliary output 3 and Digital 6 | R603B, R619B and SW601 switch 2 ON            | TBA0M0x Auxiliary Output 3 and P100 Pin 37 parallel connection to TB8100 Digital In 6 (5V logic)  |
|     |                                   |                                  | R603B, R621A and SW601 switch 2 ON            | TBA0M0x Auxiliary Output 3 and P100 Pin 38 parallel connection to TB8100 Digital In 6 (5V logic)  |
|     |                                   | Auxiliary output 3               | R603B and SW601 switch 2 ON                   | TBA0M0x Auxiliary Output 3 to TB8100 Digital In 6 (5V logic)                                      |
| 20  | Output                            | <b>Channel select 6</b>          | <b>R602A and SW601 switch 5 ON</b>            | <b>TBA0M0x Channel Select 6 to TB8100 Digital In 7</b>  |
|     |                                   | Aux Channel select 6             | R602A, R629B and SW601 switch 5 OFF           | From Aux connector to (P100 pin 46) to TB8100 Digital In 7 (5V logic)                             |
|     |                                   | Digital 7                        | R602B, R616B and SW601 switch 4 OFF           | From Aux connector to (P100 pin 34) to TB8100 Digital In 7 (5V logic)                             |
|     |                                   |                                  | R602B, R616B and SW601 switch 4 ON            | TBA0M0x Auxiliary Output 2 and P100 Pin 34 parallel connection to TB8100 Digital In 7 (5V logic). |
|     |                                   | Auxiliary output 2               | R602B and SW601 switch 4 ON                   | TBA0M0x Auxiliary Output 2 to TB8100 Digital In 7 (5V logic)                                      |
| 21  | Output                            | Channel select 7                 | R601A and SW601 switch 7 ON                   | TBA0M0x Channel Select 7 to TB8100 Digital In 6   |
|     |                                   | Aux Channel select 7             | R601A, R630B, R631A and SW601 switch 7 OFF    | From Aux connector to (P100 pin 47) to TB8100 Digital In 8 (5V logic)                             |
|     |                                   | Digital 8                        | R601B, R606B, R608A and SW601 switch 6 OFF    | From Aux connector to (P100 pin 27) to TB8100 Digital In 8 (5V logic)                             |
|     |                                   |                                  | R601B, R606B, R608A and SW601 switch 6 ON     | TBA0M0x Auxiliary Output 1 and P100 Pin 27 parallel connection to TB8100 Digital In 8 (5V logic). |
|     |                                   | <b>Auxiliary output 1</b>        | <b>R601B and SW601 switch 6 ON</b>            | <b>TBA0M0x Auxiliary Output 1 to TB8100 Digital In 8 (5V logic)</b>                               |
| 22  | Output                            | <b>Auxiliary output 0</b>        |   | <b>TBA0M0x Auxiliary Output 0 to TB8100 Digital In 9 (5V logic)</b>                               |
|     |                                   | Digital 9                        | R610A   | TBA0M0x Auxiliary Output 0 and P100 Pin 29 parallel connection to TB8100 Digital In 9 (5V logic)  |
| 23  | Output                            | <b>CTCSS defeat</b>              | <b>R600A</b>                                  | <b>TBA0M0x CTCSS defeat control line to TB8100 Digital In 10 (5V logic)</b>                       |
|     |                                   | Auxiliary output 3               | R600B and SW601 switch 2 OFF                  | TBA0M0x Auxiliary Output 3 to TB8100 Digital In 10 (5V logic)                                     |
|     |                                   | Digital 10                       | R600B, R628A and SW601 switch 2 OFF           | TBA0M0x Auxiliary Output 3 and P100 Pin 45 parallel connection to TB8100 Digital In 10 (5V logic) |
| 24  | Input                             | <b>Coax relay driver</b>         | <b>R606A and R607A</b>                        | <b>From TB8100 Tx relay (open collector) to Aux connector (P100 pin27)</b>                        |
| 25  | Ground                            | <b>Ground</b>                    |   |   |

a. Bold shaded cells indicate default values.

## 7.7 TBA0M0x Programming

This section describes how to program the tone remote settings as required for operation with the TB8100.



**Note** Unless otherwise specified, the term “Tone Remote Programming Application” used in this manual refers to version 1.08 or later.



The two settings that must to be properly set are the channel select output characteristic and the RSSI signal characteristic (if voting is required).

- On the General Settings Form, ensure that the Use Momentary Channel Select option is **not** checked.
- If Sliding Voting Tone or Simoco/Philips Standard is used, adjust the RSSI signal characteristic as follows.
  1. On the Voting/Levels Form, use the drop down menu from the Characteristic field and select User Defined.
  2. Adjust the curve using the Voltage and Signal Level adjustments, so that the tone remote RSSI curve matches the TB8100 curve, as shown in [Figure 7.7](#).

**Figure 7.7 Programming RSSI Signal Strength**

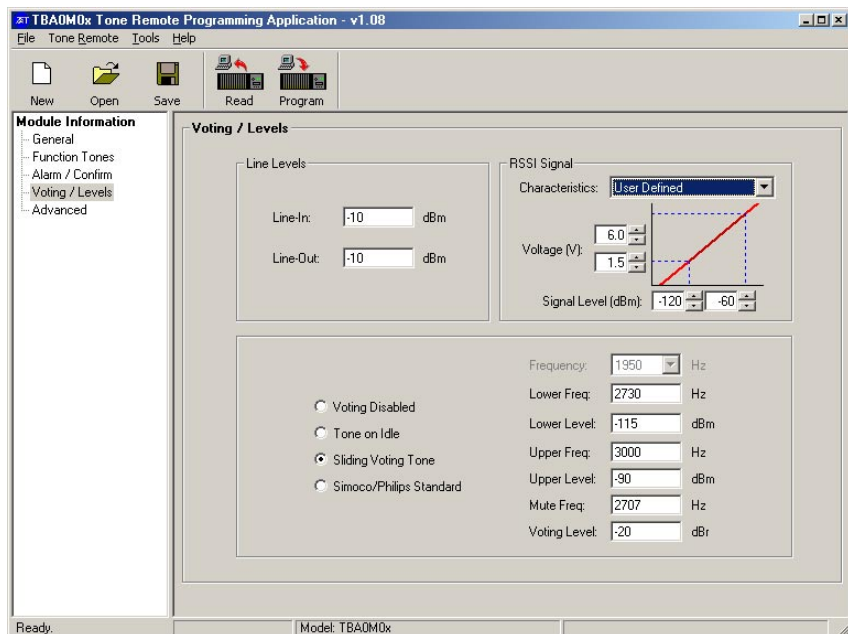

| RF Signal Strength | RSSI Voltage |
|--------------------|--------------|
| -120dBm            | 1.5V         |
| -60dBm             | 6.0V         |

## 7.8 The Aux Connector

Figure 7.8 TBA0M0x Aux connector

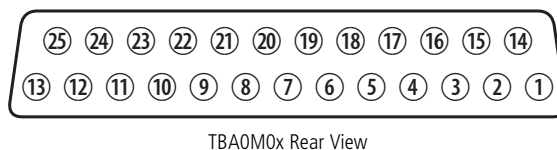

The Aux connector not only provides access to the TBA0M0x I/O, but also allows connection to the TB8100 system interface (SIF) so that communication with the base station I/O is still possible even when the TBA0M0x is connected to the base station. The most commonly used I/O is provided by the default pin allocations on the Aux Connector.

### 7.8.1 Default Pin Allocation

- Direct connection to or from the TB8100 base station for:
  - Coax relay driver
  - RSSI
  - Tx Audio (high impedance input, unbalanced)
  - Rx Audio (high impedance output, unbalanced)
  - Digital Outputs 1 and 2
  - +13.8V supplied by the 40W auxiliary power supply fitted to the TB8100 PMU. Current limited to 3A.
- All TBA0M0x Auxiliary outputs
- Tx key output from TBA0M0x
- Rx Gate input to TBA0M0x
- Channel select output from TBA0M0x (128 channel binary format)
- TBA0M0x Alarm Inputs 0 and 1
- A Serial Comms connection.

**Table 7.2 Default Aux connector pin allocations**

| Pin | Name               | TBA0M0x links and/or switch settings | Signal Type      | Notes   |
|-----|--------------------|--------------------------------------|------------------|---|
| 1   | +13.8V             |                                      | Power output     | Current limited to 3A by the 40W auxiliary power supply |
| 2   | Coax relay driver  | R606A and R607A                      | Output           | From TB8100 Tx relay (open collector)                   |
| 3   | RSSI               |                                      | DC signal output | From TB8100   |
| 4   | Auxiliary Output 0 | R610A                                | Output           | From TBA0M0x. Open collector                            |
| 5   | Tx Audio In        | R611A                                | Audio input      | To TB8100. High impedance unbalanced                    |
| 6   | Rx Audio Out       | R612B and SW600 switch 4 ON          | Audio output     | From TB8100. High impedance unbalanced.                 |
| 7   | Digital Out 1      | R643 and R605A                       | Output           | From TB8100 Digital Out 1 (open collector)              |
| 8   | Alarm 0 In         | R615B (R605B not fitted)             | Input            | To TBA0M0x Alarm input 0 (5V logic)                     |
| 9   | Auxiliary Output 2 | R616B and SW601 switch 4 ON          | Output           | From TBA0M0x. Open collector                            |
| 10  | Digital Out 2      | R644 and R604A                       | Output           | From TB8100 Digital Out 2 (open collector)              |
| 11  | Alarm 1 In         | R618B (R604B not fitted)             | Input            | To TBA0M0x Alarm input 1 (5V logic)                     |
| 12  | Auxiliary Output 3 | R619B and SW601 switch 2 ON          | Output           | From TBA0M0x. Open collector                            |
| 13  | CTCSS Defeat       | R621B                                | Output           | From TBA0M0x. Open collector                            |
| 14  | Tx Key Out         |                                      | Output           | From TBA0M0x. Open collector                            |
| 15  | Channel Select 0   | DIP SW600 switch 5 ON                | Output           | From TBA0M0x. 5V Logic (Active high)                    |
| 16  | Channel Select 1   | DIP SW600 switch 6 ON                |                  |   |
| 17  | Channel Select 2   | DIP SW600 switch 7 ON                |                  |   |
| 18  | Channel Select 3   | DIP SW600 switch 8 ON                |                  |   |
| 19  | Channel Select 4   | DIP SW601 switch 1 ON                |                  |   |
| 20  | Channel Select 5   | R628B and SW601 switch 3 ON          |                  |   |
| 21  | Channel Select 6   | R629B and SW601 switch 5 ON          |                  |   |
| 22  | Auxiliary Output 1 | R630A                                | Output           | From TBA0M0x. Open collector                            |
| 23  | Rx Gate In         |                                      | Input            | To TBA0M0x. 5V logic                                    |
| 24  | Serial Comms       | DIP SW601 switch 8 OFF (slave)       |                  | Ping-Pong protocol. See details below                   |
| 25  | Ground             |                                      | Ground           |   |

## 7.8.2 Alternative Pin Allocations

There are more possible inputs and outputs than there are available connector pins. Consequently, in order to help prevent loss of accessibility, many of the inputs and outputs can be linked to more than just one connector pin. This provides a high degree of flexibility.

[Table 7.3](#) shows all the TB8100 connector input/output possibilities. The table is arranged by I/O name so that you can find the input/output you want and decide which pin you then want to use. This can then be checked against the default values in [Table 7.2](#) to decide if the signal you are replacing also needs to be reallocated to another pin.

For example, if a third alarm input (Alarm 2 In) is required, [Table 7.3](#) indicates that pin 7 or 8 may be used. Checking against [Table 7.2](#), pin 7 is allocated to Digital Out 1. If we wish to keep Digital Out 1, it could in turn be reallocated to pin 9.

**Pins 15 to 21** are the default TBA0M0x Channel select outputs (128 channel binary format). However, they can also be used as Channel select inputs to the TB8100. Alternatively by programming the required TB8100 SIF pins accordingly these inputs can become TB8100 Digital Inputs (1 to 8). These are then available for use by TB8100 tasks.

**Tx Out-** and **Tx Out+** are parallel connected to the 600 $\Omega$  balanced Tx Audio path between the TBA0M0x and the TB8100. Consequently if this audio is to be accessed on the Aux connector this must be done using a high impedance load, thereby not upsetting the match or levels between the TBA0M0x and the base station. An example of when this may be required is if the Tx Audio is routed through an external device (connected to the Aux Connector) and processed before being passed to the base station on the unbalanced Tx Audio path (Aux pin 5 or 22).

A Serial Comms connection is available. This is a Ping-Pong protocol bus. By linking this connection (and ground) between modules, all the connected modules can be programmed via a RS232 on a single master module. The slave modules must have switch 8 of DIP SW601 switched OFF. The Tone Remote Programming Application will then detect and identify each connected module.

Refer also to the TBA0M01/2 Tone Remote and Alarm Interface PCB Information Package for detailed information on identifying and locating components on the main circuit board.

**Table 7.3 Aux connector possible pin allocations**

| I/O Name                  | Signal Type  | Pin       | Required TBA0M0x links and/or switch settings | Notes  |  |
|---------------------------|--------------|-----------|---|--|--|
| +13.8V                    | Power output | 1         | <b>Direct Connection</b>                      | Current Limited to 3A by the 40W Auxiliary Power supply. |  |
| Alarm 0 in <sup>a</sup>   | Input        | 8         | <b>R615B (R605B not fitted)</b>               | To TBA0M0x Alarm input 0 (5V logic).                     |  |
|                           |              | 9         | R616A and R634A (R605B not fitted)            |  |  |
| Alarm 1 in                | Input        | 11        | <b>R618B (R604B not fitted)</b>               | To TBA0M0x Alarm input 1 (5V logic).                     |  |
|                           |              | 12        | R619A and R620A (R604B not fitted)            |  |  |
| Alarm 2 in                | Input        | 7         | R614B   | To TBA0M0x Alarm input 2 (5V logic).                     |  |
|                           |              | 8         | R615A   |  |  |
| Alarm 3 in                | Input        | 10        | R617B   | To TBA0M0x Alarm input 3 (5V logic).                     |  |
|                           |              | 11        | R618A   |  |  |
| Alarm A in                | Input        | 7         | R643 (R605A not fitted)                       | To TBA0M0x Alarm input A (5V logic).                     |  |
| Alarm B in                | Input        | 10        | R644 (R604A not fitted)                       | To TBA0M0x Alarm input B (5V logic).                     |  |
| Aux Channel select 0      | Input        | 15        | DIP SW600 switch 5 OFF                        | To TB8100 Digital In 1 (5V logic).                       |  |
| Aux Channel select 1      | Input        | 16        | DIP SW600 switch 6 OFF                        | To TB8100 Digital In 2 (5V logic).                       |  |
| Aux Channel select 2      | Input        | 17        | DIP SW600 switch 7 OFF                        | To TB8100 Digital In 3 (5V logic).                       |  |
| Aux Channel select 3      | Input        | 18        | DIP SW600 switch 8 OFF                        | To TB8100 Digital In 4 (5V logic).                       |  |
| Aux Channel select 4      | Input        | 19        | DIP SW601 switch 1 OFF                        | To TB8100 Digital In 5 (5V logic).                       |  |
| Aux Channel select 5      | Input        | 20        | R628B, R603A and SW601 switch 3 OFF           | To TB8100 Digital In 6 (5V logic).                       |  |
| Aux Channel select 6      | Input        | 21        | R629B, R602A and SW601 switch 5 OFF           | To TB8100 Digital In 7 (5V logic).                       |  |
| Aux Channel select 7      | Input        | 22        | R630B, R631A, R601A and SW601 switch 7 OFF    | To TB8100 Digital In 8 (5V logic).                       |  |
| <b>Auxiliary output 0</b> | Output       | <b>4</b>  | <b>R610A</b>                                  | From TBA0M0x. Open collector.                            |  |
| <b>Auxiliary output 1</b> | Output       | <b>22</b> | <b>R630A</b>                                  |  |  |
|                           |              | 2         | R606B, R608A and Sw601 switch 6 ON            |  |  |
| <b>Auxiliary output 2</b> | Output       | <b>9</b>  | <b>R616B and SW601 switch 4 ON</b>            |  |  |
|                           |              | 21        | R629A   |  |  |
| <b>Auxiliary output 3</b> | Output       | <b>12</b> | <b>R619B and SW601 switch 2 ON</b>            |  |  |
|                           |              | 13        | R621A and SW601 switch 2 ON                   |  |  |
|                           |              | 20        | R628A   |  |  |
| <b>Channel select 0</b>   | Output       | <b>15</b> | <b>DIP SW600 switch 5 ON</b>                  |  | From TBA0M0x (5V Logic – active high). |
| <b>Channel select 1</b>   |              | <b>16</b> | <b>DIP SW600 switch 6 ON</b>                  |  |  |
| <b>Channel select 2</b>   |              | <b>17</b> | <b>DIP SW600 switch 7 ON</b>                  |  |  |
| <b>Channel select 3</b>   |              | <b>18</b> | <b>DIP SW600 switch 8 ON</b>                  |  |  |
| <b>Channel select 4</b>   |              | <b>19</b> | <b>DIP SW601 switch 1 ON</b>                  |  |  |
| <b>Channel select 5</b>   |              | <b>20</b> | <b>R628B and SW601 switch 3 ON</b>            |  |  |
| <b>Channel select 6</b>   |              | <b>21</b> | <b>R629B and SW601 switch 5 ON</b>            |  |  |
| Channel select 7          |              | 22        | R630B, R631A and SW601 switch 7 ON            |  |  |
| <b>Coax relay driver</b>  | Output       | <b>2</b>  | <b>R606A and R607A</b>                        | From TB8100 Tx relay. Open collector.                    |  |
| CTCSS Audio               | Audio output | 2         | R606A and R607B                               | Currently unavailable.                                   |  |
| <b>CTCSS Defeat</b>       | Output       | <b>13</b> | <b>R621B</b>                                  | From TBA0M0x (open collector).                           |  |
| Digital in 1              | Input        | 15        | DIP SW600 switch 5 OFF                        | To TB8100 Digital In 1 (5V logic).                       |  |

**Table 7.3 Aux connector possible pin allocations (Continued)**

| I/O Name             | Signal Type      | Pin       | Required TBA0M0x links and/or switch settings      | Notes  |
|----------------------|------------------|-----------|--|--|
| Digital in 2         | Input            | 16        | DIP SW600 switch 6 OFF                             | To TB8100 Digital In 2 (5V logic).   |
| Digital in 3         | Input            | 17        | DIP SW600 switch 7 OFF                             | To TB8100 Digital In 3 (5V logic).   |
| Digital in 4         | Input            | 18        | DIP SW600 switch 8 OFF                             | To TB8100 Digital In 4 (5V logic).   |
| Digital in 5         | Input            | 19        | DIP SW601 switch 1 OFF                             | To TB8100 Digital In 5 (5V logic).   |
| Digital in 6         | Input            | 12        | R619B, R603B and SW601 switch 2 ON                 | To TB8100 Digital In 6 (5V logic) with parallel connection from TBA0M0x Auxiliary output 3.  |
|                      |                  |           | R619B, R603B and SW601 switch 2 OFF                | Switch 2 OFF prevents TBA0M0x Auxiliary output 3 connection to TB8100.                       |
|                      |                  | 13        | R621A, R603B and SW601 switch 2 ON                 | To TB8100 Digital In 6 (5V logic) with parallel connection from TBA0M0x Auxiliary output 3.  |
|                      |                  |           | R621A, R603B and SW601 switch 2 OFF                | Switch 2 OFF prevents TBA0M0x Auxiliary output 3 connection to TB8100.                       |
|                      |                  | 20        | R628A, R603B and SW601 switch 2 ON                 | To TB8100 Digital In 6 (5V logic) with parallel connection from TBA0M0x Auxiliary output 3.  |
|                      |                  |           | R628B, R603A and SW601 switch 3 OFF                | To TB8100 Digital In 6 (5V logic).   |
| Digital in 7         | Input            | 9         | R616B, R602B and SW601 switch 4 ON                 | To TB8100 Digital In 7 (5V logic) with parallel connection from TBA0M0x Auxiliary output 2.  |
|                      |                  |           | R616B, R602B and SW601 switch 4 OFF                | Switch 4 OFF prevents TBA0M0x Auxiliary output 2 connection to TB8100.                       |
|                      |                  | 21        | R629A, R602B and SW601 switch 4 ON                 | To TB8100 Digital In 7 (5V logic) with parallel connection from TBA0M0x Auxiliary output 2.  |
|                      |                  |           | R629B, R602A and SW601 switch 5 OFF                | To TB8100 Digital In 7 (5V logic).   |
| Digital in 8         | Input            | 2         | R606B, R608A, R601B and SW601 switch 6 OFF         | To TB8100 Digital In 8 (5V logic).   |
|                      |                  | 22        | R630A, R601B and SW601 switch 6 ON                 | To TB8100 Digital In 8 (5V logic) with parallel connection from TBA0M0x Auxiliary output 1.  |
|                      |                  |           | R630B, R631A, R601A and SW601 switch 7 OFF         | To TB8100 Digital In 8 (5V logic).   |
| Digital In 10        | Input            | 20        | R628A and R600B                                    | To TB8100 Digital In 10 (5V logic) with parallel connection from TBA0M0x Auxiliary output 3. |
| <b>Digital Out 1</b> | Output           | <b>7</b>  | <b>R643 and R605A. (R614A or R614B not fitted)</b> | From TB8100 Digital Out 1. Open collector. Also connects to TBA0M0x Alarm Input A.           |
|                      |                  | 8         | R615B and R605B (R634A not fitted)                 | From TB8100 Digital Out 1. Open collector. Also connects to TBA0M0x Alarm Input 0.           |
|                      |                  | 9         | R616A, R634A and R605B                             |  |
| <b>Digital Out 2</b> | Output           | <b>10</b> | <b>R644 and R604A. (R617A or R617B not fitted)</b> | From TB8100 Digital Out 2. Open collector. Also connects to TBA0M0x Alarm Input B.           |
|                      |                  | 11        | R618B and R604B (R620A not fitted)                 | From TB8100 Digital Out 2. Open collector. Also connects to TBA0M0x Alarm Input 1.           |
|                      |                  | 12        | R619A, R620A and R604B                             |  |
| <b>Ground</b>        | Ground           | 25        | Direct Connection                                  | Ground.  |
| <b>RSSI</b>          | DC signal output | 3         | Direct Connection                                  | From TB8100.   |
| RX Audio in          | Audio input      | <b>6</b>  | R612B and SW600 switch 4 OFF                       | To TBA0M0x. High impedance unbalanced.   |
| <b>Rx Audio out</b>  | Audio output     |           | <b>R612B and SW600 switch 4 ON</b>                 | From TB8100. High impedance unbalanced.  |
| <b>Rx gate in</b>    | Input            | <b>23</b> | <b>Direct Connection</b>                           | To TBA0M0x (5V logic).   |
| Rx gate out          | Output           | 12        | R 619A, R620B and SW600 switch 3 ON                | From TB8100. Open collector.   |
|                      |                  |           | R 619A, R620B and SW600 switch 3 OFF               | Switch 3 OFF disconnects TBA0M0x from TB8100 Rx gate.  |

**Table 7.3 Aux connector possible pin allocations (Continued)**

| I/O Name            | Signal Type  | Pin       | Required TBA0M0x links and/or switch settings | Notes   |
|---------------------|--------------|-----------|---|---|
| Rx out-             | Audio output | 7         | R614A. (R643 not fitted)                      | From TB8100. Balanced 600Ω.   |
| Rx out+             | Audio output | 4         | R610B   |   |
|                     |              | 6         | R612A   |   |
| <b>Serial Comms</b> |              | <b>24</b> | <b>DIP SW601 switch 8 OFF (slave)</b>         | Ping-Pong protocol. See note above.                                     |
| Shift mix           | Output       | 2         | R606B and R608B                               | From TBA0M0x. Open collector.   |
| <b>Tx audio in</b>  | Audio input  | <b>5</b>  | <b>R611A</b>                                  | To TB8100. High impedance unbalanced.                                   |
|                     |              | 22        | R630B and R631B                               |   |
| Tx key in           | Input        | 9         | R616A and R634B and SW600 switch 2 ON         | Additional method of keying TB8100 (8V logic).                          |
|                     |              |           | R616A and R634B and SW600 switch 2 OFF        | SW600 switch 2 OFF prevents the TBA0M0x from keying TB8100 transmitter. |
| <b>Tx key out</b>   | Output       | <b>14</b> | <b>Direct Connection</b>                      | From TBA0M0x. Open collector.   |
| Tx out-             | Audio output | 10        | R617A. (R644 not fitted)                      | Transmit audio from TBA0M0x. See note above.                            |
| Tx out+             | Audio output | 5         | R611B   |   |

a. Bold shaded cells indicate default values.

### 7.8.3 Aux Connector I/O specifications

The following tables describe the specifications and ratings of the signals available on the TBA0M0x Aux connector when the TBA0M0x is connected to the TB8100 base station.



#### ***Important***

If two different inputs or outputs are used in parallel ensure that the lower rating is used.

For example, the TB8100 Digital Input (max input 20V) is driven by the TBA0M0x Auxiliary Output (max input 50V) and also by an external Digital In on the Aux Connector. The maximum voltage input level of the external Digital In must not exceed the 20V of the TB8100 Digital Input.



**Table 7.4 Logic signal and supply voltage specifications**

| Name               | Signal path    | Logic levels   | Ratings  |
|--------------------|----------------|--|--|
| +13.8V             | TB8100 output  | —  | Current limited to 3A by the PMU 40W Auxiliary power supply.   |
| Alarm In           | TBA0M0x input  | $\geq 3.5V$ (deactivated)<br>$\leq 1.5V$ (activated)                     | Max input voltage = 5V   |
| Aux Channel select | TB8100 input   | $\geq 3.5V$ (deactivated)<br>$\leq 1.5V$ (activated)                     | Internal pull-up to +5V<br>Input resistance = 1.8k $\Omega$<br>Logic sense can be inverted by TB8100 programming |
| Auxiliary output   | TBA0M0x output | open collector<br>0V = active  | Max applied voltage = 50V<br>Max sink current = 100mA  |
| Channel select     | TBA0M0x output | 5V CMOS<br>5V = active   | Max applied voltage = 20V<br>Max sink current = 20mA   |
| Coax relay driver  | TB8100 output  | open collector<br>< 0.4V = active  | Max applied voltage = 30V<br>Max sink current = 250mA  |
| CTCSS defeat       | TBA0M0x output | open collector<br>0V = active  | Max applied voltage = 50V<br>Max sink current = 250mA  |
| Digital In         | TB8100 input   | $\geq 3.5V$ (deactivated)<br>$\leq 1.5V$ (activated)                     | Internal pull-up to +5V<br>Input resistance = 1.8k $\Omega$<br>Logic sense can be inverted by TB8100 programming |
| Digital Out        | TB8100 output  | open collector<br>< 0.4V = active  | Max applied voltage = 30V<br>Max sink current = 100mA  |
| RSSI               | TB8100 output  | Output level range 0.5V to 6V<br>for RF input range<br>-120dBm to -60dBm | 800 $\Omega$ output impedance  |
| Rx gate in         | TBA0M0x input  | 5V logic<br>0V = audio   | Max input voltage = 50V  |
| Rx gate out        | TB8100 output  | open collector<br>< 0.4V = active  | Max applied voltage = 30V<br>Max sink current = 250mA  |
| Shift mix          | TBA0M0x output | open collector<br>0V = active  | Max applied voltage = 50V<br>Max sink current = 250mA  |
| Tx key in          | TB8100 input   | $\leq 2.0V$ (TXKEY = activated)<br>$\geq 5.0V$ (TXKEY = deactivated)     | Input resistance $\geq 10k\Omega$<br>Internal pull up to 8V<br>Max external pull up = 20V                        |
| Tx key out         | TBA0M0x output | open collector<br>0V = active  | Max applied voltage = 50V<br>Max sink current = 250mA  |

**Table 7.5 Audio Signal Specifications**

| Name         | Signal path                     | Specifications  |
|--------------|---------------------------------|---|
| Rx Audio In  | TBA0M0x input                   | Unbalanced high impedance input (>10kΩ). Level required for correct operation of TBA0M0x is 230mV <sub>rms</sub>  |
| Rx Audio Out | TB8100 output                   | Unbalanced output, should only be used with high impedance loads (>10kΩ).<br>The output level is adjustable 0.3V <sub>pp</sub> to 3.0V <sub>pp</sub> , for 60% modulation (0.1V resolution). When this output is used by the TBA0M0x the level must be set to 0.6V <sub>pp</sub> .  |
| Rx Out+      | TB8100 output                   | Balanced 600Ω audio interface. The output level is adjustable -20dBm to +10dBm for 60% modulation (0.1 dB resolution). May be transformer isolated or AC coupled depending on the SIF. Not used by the TBA0M0x.   |
| Rx Out-      |                                 |   |
| TX Audio in  | TB8100 input                    | Unbalanced high impedance input (>10kΩ). The input level is adjustable 0.3V <sub>pp</sub> to 3.0V <sub>pp</sub> , for 60% modulation.   |
| Tx Out-      | TBA0M0x output/<br>TB8100 input | Parallel connection to the 600Ω balanced Tx Audio path between the TBA0M0x and the TB8100. Consequently if this audio is to be accessed on the Aux connector, this must be done using a high impedance load, thereby not upsetting the match/levels between the TBA0M0x and the base station. Output level -4.4dBm (when the Line-In level is properly set-up or when the TBA0M0x is in Test Tone Mode) |
| Tx Out+      |                                 |   |

## 8 Level Configuration

Before using the TBA0M0x, the audio input and output levels need to be properly configured. This includes line input and output levels, the level from the receiver and the level presented to the base station transmitter. This section describes how this is done.

**Figure 8.1** TBA0M0x setup

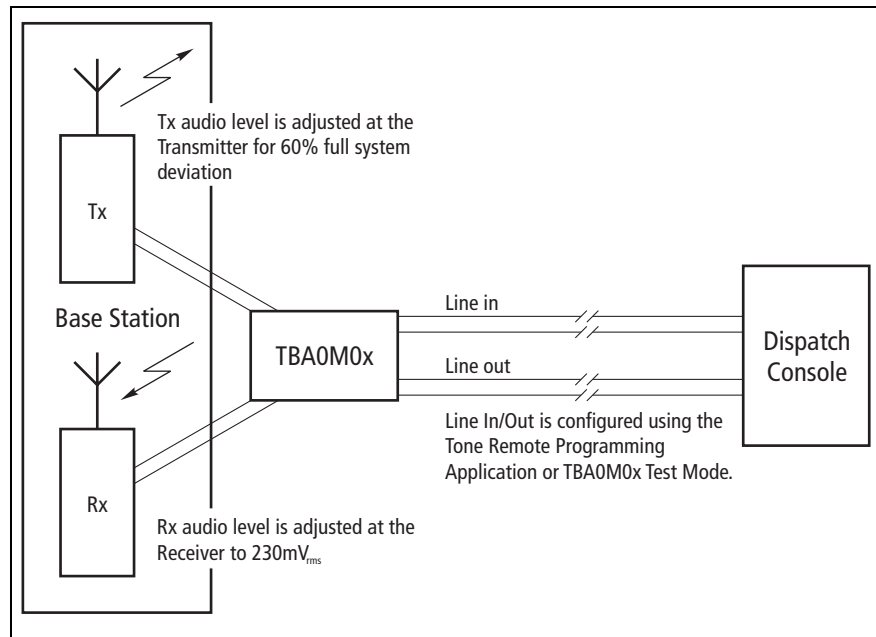

The Line-In and Line-Out levels can be set up using either the Tone Remote Programming Application or the test modes of the TBA0M0x (accessed via the buttons on the front panel – see [Section 4.8](#)). The advantage of the test mode method is that it can provide a direct test of the system. The programming method is required when access to the far end dispatch console is difficult.

Using the test modes, the TBA0M0x line levels are set up using actual signals present on the line. For the Line-In level, the test tone and keytone, are generated by the dispatch console and sent to the TBA0M0x via the leased line (or an audio generator could be used with the line loss simulated). For the Line-Out level, the test tone is generated by the TBA0M0x.

Programming the Line-In/Line-Out levels using the Tone Remote Programming Application does not require any connection to the line. However, input and output specifications of the dispatch console and actual line loss must be known so that the TBA0M0x levels can be properly calculated and programmed.

Setting up the receiver and transmitter audio levels can only be done on the base station. For the TB8100, this is achieved by programming the base station using the TB8100 Service Kit. On the TB7100, these are adjusted on the rear panel. The levels can be checked using the TBA0M0x test mode.

## 8.1 Line Interface

The following table describes the pin allocations for interfacing with the TBA0M0x on two-wire and four-wire networks.

**Figure 8.2 Line Interface pin allocations**

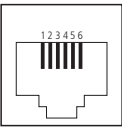
|  | RJ45 pins | Two-Wire      | Four-Wire |
|--|-----------|---------------|-----------|
|  <p>external view</p> | 2         | NC            | LineOut+  |
|  | 3         | Line In / Out | LineIn+   |
|  | 4         | Line In / Out | LineIn-   |
|  | 5         | NC            | LineOut-  |

The TBA0M0x accommodates an input signal range of 28dB. Normally this is sufficient, however by shorting JP200 (found on the TBA0M0x circuit board) an extra 15dB gain is added.

## 8.2 Equipment Setup for Level Configuration.

Configuring the TBA0M0x Line levels (using the Tone Remote Programming Application or test mode) and radio receiver or transmitter levels requires the sub-rack and test equipment to be set up as shown below.

**Figure 8.3 Rack and test equipment setup**

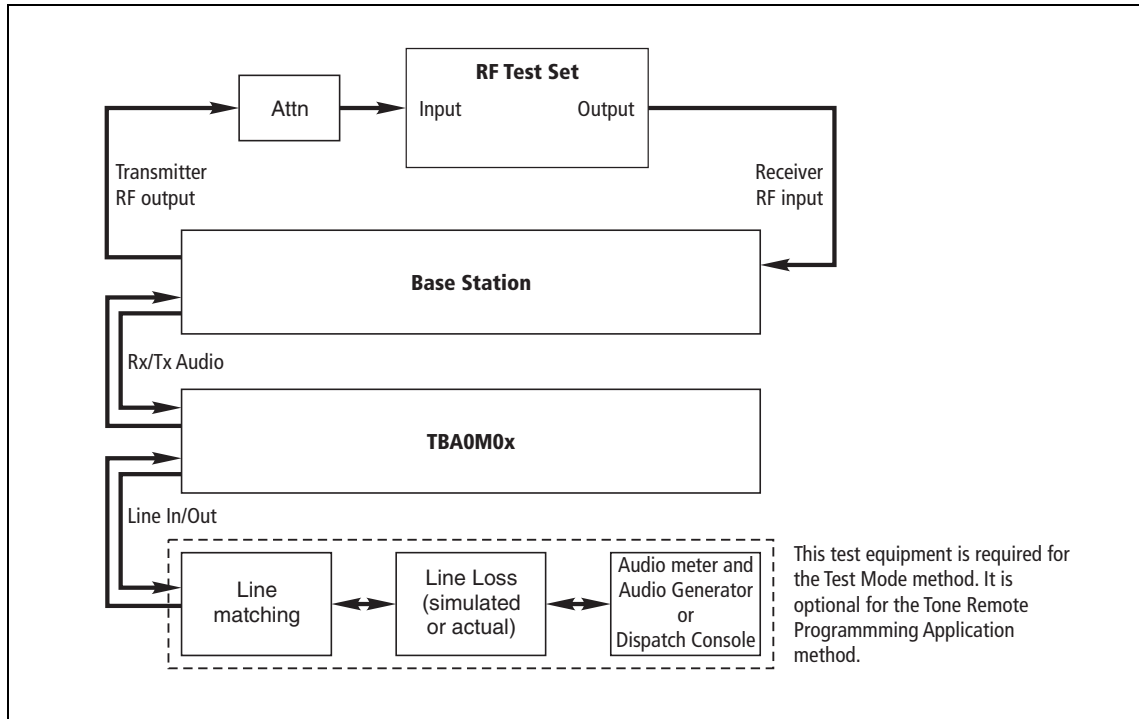

Remove any coaxial relay or duplexer in the base station modules' RF path and connect them directly to an RF Test Set. Ensure that transmitter or PA RF output is sufficiently attenuated to prevent damage to the test set. The following levels need to be set in the following order:

1. Tx Audio – Audio level from the TBA0M0x to the transmitter (balanced)
2. Rx Audio – Audio level from the receiver to the TBA0M0x (unbalanced)
3. Line-In level
4. Line-Out level

## 8.3 Tx/Rx Level Configuration (TB7100)

This section describes how to set the audio levels between the TBA0M0x tone remote and the TB7100. Both the Tx audio and the Rx audio levels are adjusted on the rear panel of the TB7100.

Before proceeding with any level configuration ensure that the equipment has been setup correctly as in [Section 8.2](#). It is important that the transmitter output is connected to the Test Set (through a load as required) because the transmitter will be often keyed during these procedures.

**Figure 8.4** Location of level adjustment pots on TB7100 rear panel

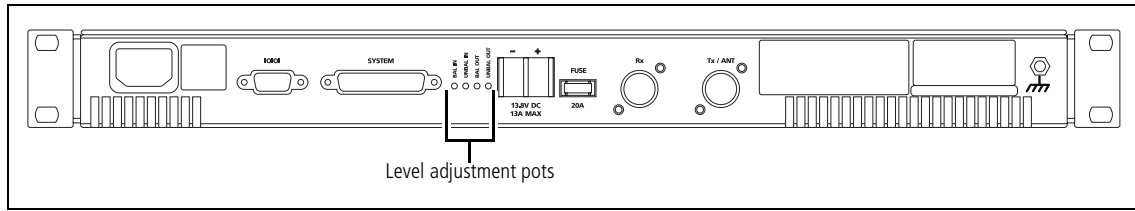

### 8.3.1 Tx Audio Adjustment

Setup the equipment as shown in [Figure 8.3](#).

1. Use the test set to monitor the TB7100 transmitter deviation. Set the de-emphasis filter **ON**.
2. Set the TBA0M0x into Test Tone Mode by pressing the Monitor and Mode toggle buttons on the front, simultaneously<sup>1</sup>. Note that the Test Tone Mode will time out after 1 minute. Reactivate if necessary.
3. While monitoring the transmitter deviation, adjust the Tx Audio level using BAL IN (RV500) on the TB7100 rear panel, for 60% of maximum system deviation. Maximum system deviation will depend on the channel spacing used (see [Table 8.1](#)).

**Table 8.1** System Deviation for different Channel Spacings

| Channel Spacing     | Equivalent Max Tx Deviation (Hz) | 60% of Max Tx Deviation (Hz) |
|---------------------|----------------------------------|------------------------------|
| 12.5kHz Narrow Band | 2500                             | 1500                         |
| 20kHz Mid Band      | 4000                             | 2400                         |
| 25kHz Wide Band     | 5000                             | 3000                         |

### 8.3.2 Rx Audio Adjustment



**Note** The Tx Audio Level must be set before starting this procedure.

Setup the equipment as shown in [Figure 8.3](#).

Use the test set in Duplex Mode to generate an on-channel signal to open the mute of the TB7100 receiver. Modulate the RF carrier with 1020Hz tone at 60% full system deviation (adding CTCSS tone if necessary).

There are two methods to set up the Rx Audio level.

1. See [Section 4.8](#) for more information on Test Modes.

- Method 1**
1. Set the TBA0M0x into Talk-Through Mode by pressing the mode toggle button on the front. This will key the TB7100 transmitter.
  2. While monitoring the transmitter deviation on the test set (with the de-emphasis filter OFF) adjust the Rx Audio level using UNBAL OUT (RV502) on the TB7100 rear panel, for 60% of maximum system deviation. Maximum system deviation will depend on the channel spacing used (see [Table 8.1](#)).
- Method 2**
1. Measure Pin 24 of the TB7100 system interface connector with an oscilloscope (or a high impedance multimeter).
  2. Using UNBAL OUT (RV502) on the TB7100 rear panel, adjust the Rx audio level until  $230\text{mV}_{\text{rms}}$  ( $650\text{mV}_{\text{pp}}$ ) is measured.



**Important** The Rx Audio level must not exceed  $230\text{mV}_{\text{rms}}$  ( $650\text{mV}_{\text{pp}}$ ) as specified in this procedure. This will ensure that the actual TBA0M0x line-out level corresponds to the programmed value and ensures levels do not exceed the power level requirements of the telecommunications leased line.

## 8.4 Tx/Rx Level Configuration (TB8100)

Before proceeding with any level configuration ensure that the equipment has been setup correctly as in [Section 8.2](#). It is important that the transmitter output is connected to the Test Set (through a load as required) because the transmitter will often be keyed during these procedures.

For a TB8100 base station, the Tx Audio and the Rx Audio are both adjusted within the base station using the TB8100 Service Kit software, within the Configuration section as follows.

1. Navigate to Base Station > Channel profiles.
2. For a standard TB8100 Base Station, choose the “Default” channel profile and click the “Edit” button. For an advanced TB8100 Base Station (Advanced Profiles and Task Manager enabled) choose the channel profile name required and click the “Edit” button. The “Edit Channel Profile” window is then displayed with five tabs along the top.
3. Select the Signal Path tab (shown below in [Figure 8.5](#)). This is where the Rx and Tx Audio paths can be configured as described in the following sections.

**Figure 8.5 TB8100 Service Kit – Signal Path tab for the default channel**

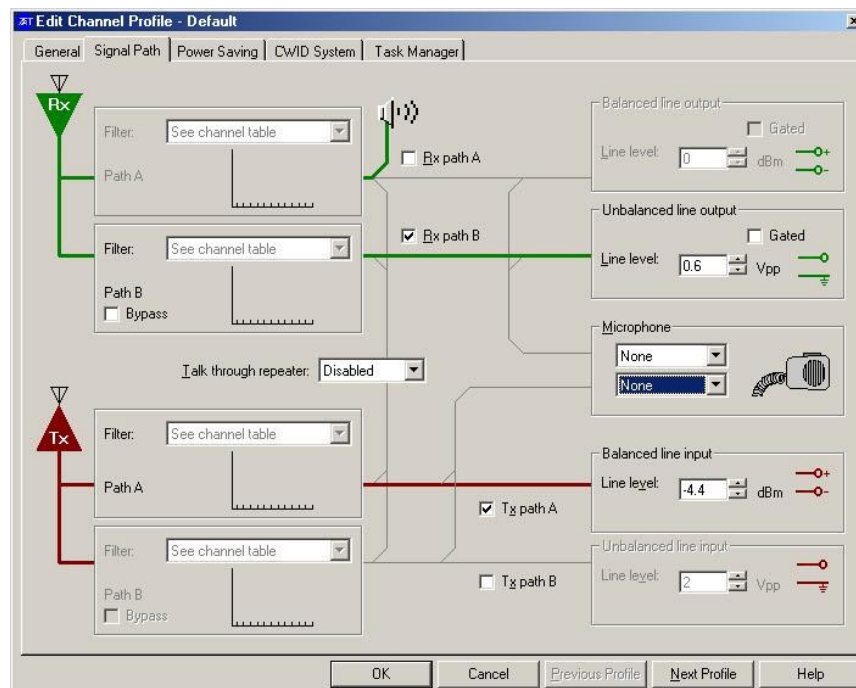

For additional help refer to the TB8100 Service Kit User’s Manual provided on the CD supplied with the base station. Additional information is also available in the TB8100 Installation Guide and TB8100 Operation Manual.

### 8.4.1 Tx Audio Adjustment

The Tx Audio level is adjusted on the input of the transmitter using the TB8100 Service Kit.

1. Using the TB8100 Service Kit read the TB8100 base station. This will load the configuration data into the Service Kit.
2. For a standard TB8100 Base Station navigate to Configuration > Base Station > Channel Table. For an advanced Base Station (Advanced Profiles and Task Manager enabled) jump to step 5.
3. Set the “Filter” of the Default channel to “Pre/De-Emph Speech Band”.
4. Click “OK”.
5. Navigate to Configuration > Base Station > Channel Profiles.
6. Select the channel profile required (see [Section 8.4](#)) and navigate to the Signal Path options tab.
7. Within the Signal Path options window:
  - Select “Tx path A”



- For advanced Base Stations only, set the Tx path filter to “Pre-Emph Speech Band”
- Set the Balanced Input level to  $-4.4\text{ dBm}$   
The Line level adjust boxes on the transmit path define the level of the line input that the Base Station expects. The line level affects the gain across the transmit path. When the base station receives a line input equal to the level programmed, it transmits at 60% of maximum transmit deviation.

#### 8. Program the TB8100.

The above configuration can be checked by putting the TBA0M0x into Test Mode<sup>1</sup>. Ensure the equipment is correctly setup as in [Section 8.2](#). In Test Mode the TBA0M0x keys the base station transmitter and outputs  $-4.4\text{ dBm}$  balanced Tx Audio (equal to average speech level). Using the RF Test Set, with the De-Emphasis filter ON, confirm that the deviation displayed equates to 60% of maximum system deviation. The maximum transmit deviation is determined by the channel spacing, or for the channels using custom profiles, it is defined by the parameter Max Tx deviation (see [Table 8.1](#)).

As another check, the TB8100 Service Kit monitoring or diagnostics tool can be used to measure and display (to the nearest 1 dBm) the actual audio level input to the base station. Within the Service Kit navigate to Monitor > Monitoring > Reciter (or Diagnose > Reciter > Audio I/O)

With the TBA0M0x in Test Mode the balanced audio input level should be displayed as  $-4\text{ dBm}$ . For more information refer to the Service Kit online help notes titled “Measuring the Audio Input Level”.

## 8.4.2 Rx Audio Adjustment

The Rx Audio level is adjusted on the output of the receiver using the TB8100 Service Kit.



**Note** The Tx Audio level must be set before starting this procedure.

1. Using the TB8100 Service Kit read the TB8100 base station. This will load the configuration data into the Service Kit.
2. For a standard TB8100 Base Station navigate to Configuration > Base Station > Channel Table. For an advanced Base Station (Advanced Profiles and Task Manager enabled) jump to step 5.
3. Set the “Filter” of the Default channel to “Pre/De-Emph Speech Band” by selecting it from the drop-down menu shown after clicking in the “Filter” field.
4. Click “OK”.

---

1. See [Section 4.8](#) for more information on Test Modes.

5. Navigate to Configuration > Base Station > Channel Profiles
6. Select the channel profile required (see [Section 8.4](#)) and navigate to the Signal Path options tab.
7. Within the Signal Path options window:
8. Select “Rx path B”
9. Set the Unbalanced line output level to  $0.6V_{pp}$  (approximately  $230mV_{rms}$ )
10. For advanced Base Stations only, set the Rx path filter to “De-Emph Speech Band”
11. Program the TB8100



**Important** The Rx audio level must not exceed the  $230mV_{rms}$  specified in this procedure. This will ensure that the actual TBA0M0x line-out level corresponds to the programmed value and thus ensures levels do not exceed the power level requirements of the telecommunications leased line.

If desired, three different methods can be used to confirm that the level is correctly set:

- Direct measurement of Rx Audio on the TBA0M0x Aux Connector (P100 Pin 31)
- Using TB8100 transmitter deviation
- Using TBA0M0x Line-Out

**Direct measurement of Rx Audio on the TBA0M0x Aux Connector (P100 Pin 31)**

1. Use the RF Test Set to generate an on-channel signal to un-mute the TB8100 receiver. Modulate the RF carrier with a 1020Hz tone<sup>1</sup> at 60% full system deviation (adding a CTCSS tone if necessary).
2. Measure TBA0M0x Aux Connector (P100) Pin 31 with an Oscilloscope or a high impedance multimeter (this assumes the default I/O link configuration of R612B and SW600 switch 4 ON has not been changed). The level should be approximately  $600mV_{pp}$ .

**Using TB8100 transmitter deviation**

This test requires the RF Test Set to be used in Duplex Mode with de-emphasis filter OFF on the Test Set receiver.

1. Use the RF Test Set to generate an on-channel signal to un-mute the TB8100 receiver.
2. Modulate the RF carrier with a 1020Hz tone<sup>1</sup> at 60% full system deviation (adding a CTCSS tone if necessary).

---

1. 1020Hz tone is used because some Test Sets can produce unstable deviation readings.

3. Put the TBA0M0x into Talk-Through Mode (Repeater Mode) using the mode toggle button<sup>1</sup>. The Mode LED should be red (constant or flashing) and the transmitter should be keyed-up.
4. Check for a 60% full system deviation reading on the RF Test Set. This confirms that both the Rx audio and Tx audio levels are correct as both are tested with this setup.

#### Using TBA0M0x Line-Out

1. Use the RF Test Set to generate an on-channel signal to un-mute the TB8100 receiver.
2. Modulate the RF carrier with a 1020Hz tone<sup>1</sup> at 60% full system deviation (adding a CTCSS tone if necessary).
3. Put the TBA0M0x into Base Station Mode using the mode toggle button<sup>1</sup>. The Mode LED should be green (constant or flashing).
4. Measure the TBA0M0x Line-Out level (balanced audio).
5. Using the Tone Remote Programming Application, read the TBA0M0x and note the programmed Line-Out level. The measured level (of step 4) should be the same as this programmed level if the RX Audio has been set-up correctly.

## 8.5 Line-In Level



**Note** The Tx Audio Level must be set before starting this procedure.

The Line-In level can be set up in two ways:

- With the TBA0M0x in Level Configuration Mode
- Using the Tone Remote Programming Application.

### 8.5.1 Using Level Configuration Mode:

1. Set the TBA0M0x into Line-In Level Configuration Mode (see [Section 4.8](#)).
2. Connect a dispatch console to the far end of the line (or simulate the console and line loss using an audio generator).
3. Press the PTT on the dispatch console. This will send a keytone to the TBA0M0x. Ensure the console also sends a test tone at speech level to line (This audio is required for this method of configuring the Line-In level).

---

1. The Mode Toggle button may have been disabled by the Tone Remote Programming Application.

4. The alarm LEDs on the front panel of the TBA0M0x should change to green (for as long as the PTT is pressed), indicating that a keytone has been detected.
5. Adjust the Line-In level by pressing the Monitor button (increases the level) or the Mode Toggle button (decreases the level) until the TB8100 transmitter deviation reading, monitored on the RF Test Set, indicates 60% full system deviation.
6. Press the PTT on the dispatch console again, but this time use speech instead of the test tone. Ensure the LEDs on the TBA0M0x remain constant on green during speech transmission. If not, see [Section 9.2](#) for how to troubleshoot for Talkoff.



**Note** The monitor speaker is forced on in this mode so that the test-microphone may be used as an intercom to communicate to the dispatcher room (see [Section 4.7](#)).

### 8.5.2 Using the Tone Remote Programming Application:

1. Determine the output level of the console. This may be a preset or default value specified in the console's manual or a value programmed by the operator.
2. Determine the actual line-loss between the console and the TBA0M0x.
3. Calculate TBA0M0x Line-In Level as follows:  

$$\text{TBA0M0x Line-In Level} = \text{console output level (dBm)} - \text{Line-loss (dB)}$$
4. Program the TBA0M0x with the calculated level.

Example case:

Console output level = -13 dBm

Measured Line loss = 6.5 dBm

TBA0M0x Line-In level =  $-13 - 6.5 = -19.5$  dBm

## 8.6 Line-Out Level



**Note** The Tx Audio and Rx Audio Levels must be set before starting this procedure.

The Line-Out Level can be set up in two ways:

- Using Level Configuration Mode
- Using the Tone Remote Programming Application software.

## 8.6.1 Using Level Configuration Mode

1. Set the TBA0M0x into Line-Out Level Configuration Mode (see [Section 4.8](#)).
2. Use the RF Test Set to generate an on-channel signal to un-mute the TB8100 receiver.
3. Modulate the RF carrier with a 1020Hz tone<sup>1</sup> at 60% full system deviation, adding CTCSS tone if necessary.
4. Monitor the TBA0M0x Line-Out level (balanced) and adjust by pressing the Monitor button (increases the level) or the Mode Toggle button (decreases the level) until the level is acceptable at the dispatch console.



**Note** The monitor speaker is forced on in this mode so the test-microphone may be used as an intercom to communicate to the dispatcher room (see [Section 4.7](#)).

## 8.6.2 Using the Tone Remote Programming Application software

1. Determine the input level required at the dispatch console. This may be a preset or default value specified in the console's manual or a value programmed by the operator.
2. Determine the actual line-loss between the console and the TBA0M0x.
3. Calculate TBA0M0x Line-Out Level as follows:  
TBA0M0x Line-Out Level = console input level (dBm) + Line-loss (dB)
4. Program the TBA0M0x with the calculated level.

Example case:

Console input level = -13dBm

Measured Line loss = 6.5dBm

TBA0M0x Line-Out level = -13 + 6.5 = -6.5dBm

---

1. 1020Hz tone is used because some Test Sets can produce unstable deviation readings.



# 9 Troubleshooting

---

The following sections will help find any problems if the Tone Remote does not function as expected. If problems persist, please contact Technical Support (contact details [on page 2](#)).

## 9.1 Fault Finding

1. Connect the TBA0M0x to its companion dispatch console via the leased line. Check that speech sent from the console can be heard on the TBA0M0x speaker (un-mute speaker if required).

One possible cause of incorrect operation is that the line connections have become transposed in the wiring network or that the dispatch console uses different Send/Receive pairs.

2. Use the dispatch console to key-on the transmitter. If the transmitter does not key-on, check that the console and TBA0M0x have been compatibly programmed.

- check two-wire or four-wire
- check the keytone frequency
- check if function tones are used
- check high level guard tone and function tone periods (if used) are the same

Finally check that the console is sending appropriate signal levels and that tone durations are correct (which are often variable), and that the line is not causing unacceptable attenuation or distortion.

3. If the console can key the transmitter but not change Repeater/Base Station Mode, change channel, auxiliary outputs, receiver defeat or cancel alarms, carry out the checks in Step 2 above, but pay particular attention to the function tone programming.

## 9.2 Troubleshooting Setup Problems

**Sometimes misses function tone command**

Set up the Line-In level so that the function tones are about  $1.2V_{pp}$  at TP204.

**Misses function tone sequence on very fast key repetition**

A minimum of 200ms pause is required between pressing buttons on the console. Some consoles do not limit the maximum keying rate.

**Loop-Line functionality (also known as Loopback)**

Loopback can be enabled with the Tone Remote Programming Application. It is then activated by sending the TMA0M0x the programmed function tones.

**While in Line-In Level Configuration Mode, the LEDs flash green only briefly when the dispatch console PTT is pressed**

The Line-In level is too low. The TBA0M0x is only detecting the high level guard tone (HLGT).

While still in Line-In Level Configuration Mode, activate the console PTT and adjust the Line-In level by pressing the Monitor button (increases the Line-In level) until the LEDs remain constant green. The left alarm LED will toggle on and off, indicating a level increase until the top of the range is reached (this may take up to 65 presses). If this still fails, open up the unit and add JP200, and try again.

**When the PTT is pressed, a pulsing sound can be heard from the speaker**

The Line-In level is too high. The function tones can not be decoded properly hence it keys off.

While still in Line-In Level Configuration Mode, activate the console PTT and adjust the Line-In level by pressing the Mode button. The right alarm LED will toggle on and off, indicating a level decrease until the bottom of the range is reached. Using an oscilloscope measure the signal on TP204 – the function tone level should be about half the level of the high level guard tone.

**The console keys the transmitter correctly except when speech is present.**

This is known as “Talkoff” and occurs when the difference between the keytone level and peak speech level exceeds specification (32 dB in two-wire mode and 35 dB in four-wire mode), causing the keytone detector to fail.

Adjust the relative audio levels (keytone and speech) sent from the dispatch console. For reliable operation the keytone level should be no more the 35 dB lower than the *peak* speech level.

If it is not possible to adjust the levels at the console, decrease the programmed Line-In level of the TBA0M0x until Talkoff is eliminated. This requires that the Tx Audio level (from the TBA0M0x to the TB8100 transmitter) will also need to be re-adjusted to maintain 60% full system deviation for the test tone sent from the console (see [Section 8.4.1](#) for adjusting Tx Audio using the TB8100 Service kit). As a general rule, the TB8100 Tx Audio input level will increase by the same amount as the TBA0M0x programmed Line-In level is decreased.

**Keytone Falsing in two-wire mode.**

When operating in two-wire mode with lossy lines (i.e. significant separation required between TBA0M0x Line-In and Line-Out levels) the keytone detector can become desensitised by noise.

1. Check to ensure that the Rx Audio level is setup correctly at  $230\text{mV}_{\text{RMS}}$  (see [Section 8.3.2](#) for TB7100 or [Section 8.4.2](#) for TB8100).



2. Check the TB8100 receiver gating level (squelch). If necessary adjust the receiver gating, using the TB8100 Service Kit, so that the receiver mute opens at a higher SINAD level (12dB or preferably greater). This has the effect of reducing noise on the line input of the TBA0M0x in two-wire mode.
3. If there is still a problem after the receiver gating has been adjusted as much as practicable, it becomes necessary to reduce the separation between the TBA0M0x Line-In and Line-Out levels. This separation may need to be reduced to less than 8 dB if the receiver audio SINAD is less than 12 dB (or less than 12 dB for 14 dB receiver audio SINAD). To achieve this, adjust the relative input and output levels of the dispatch console. Again this has the effect of reducing the noise on the input of the TBA0M0x.

If the above solutions do not help resolve the problem, the two-wire line loss may be too severe and unacceptable for normal two-wire TBA0M0x operation. In this case a solution involving a Rx Audio path notch filter and an external two-wire/four-wire hybrid fitted across the line, may be required.